

Report of the

---

**MULTIDISCIPLINARY INVESTIGATION OF DIFFERENTIATION AND  
POTENTIAL HYBRIDISATION BETWEEN TWO YELLOWFISH SPECIES  
*LABEOBARBUS KIMBERLEYENSIS* AND *L. AENEUS* FROM THE  
ORANGE-VAAL SYSTEM**

Follow-up study 2004-2007

Compiled by

Paulette Bloomer<sup>1</sup>, I. Roger Bills<sup>2</sup>, F. Herman van der Bank<sup>3</sup>, Martin H. Villet<sup>4</sup>, Nick Jones<sup>2</sup> and Gina Walsh<sup>3</sup>

<sup>1</sup>Molecular Ecology and Evolution Programme, Dept. of Genetics, University of Pretoria; <sup>2</sup>South African Institute for Aquatic Biodiversity, Grahamstown; <sup>3</sup>Dept. of Zoology, University of Johannesburg, <sup>4</sup>Dept. of Zoology, Rhodes University, Grahamstown

In association with the Yellowfish Working Group

and

with funding support from AngloGold Ashanti, FOSAF and the National Research Foundation

**TABLE OF CONTENTS**

	<b>Page</b>
<b>1. SUMMARY REPORT</b>	<b>4</b>
1.1 Executive summary	4
1.2 Background and aims	6
1.2.1 The genus <i>Labeobarbus</i>	6
1.2.2 Orange River yellowfishes, their distributions and principal differences	7
1.2.3 The need for the identification of conservation units and the Orange-Vaal yellowfish genetics pilot study	9
1.2.4 Aims	9
1.3 Rationale for choice of investigatory methods	10
1.3.1 Why a multi-disciplinary approach?	10
1.3.2 Morphology/Morphometrics	11
1.3.3 Allozymes	13
1.3.4 Mitochondrial DNA	14
1.4 Summary of results	15
1.4.1 Morphology/Morphometrics	15
1.4.2 Allozymes	17
1.4.3 Mitochondrial DNA	17
1.5 Conclusions and Recommendations	18
1.6 References	19
<b>2. ACKNOWLEDGEMENTS</b>	<b>20</b>

<b>3.</b>	<b>DETAILED SCIENTIFIC REPORT</b>	<b>21</b>
<b>3.1</b>	<b>Morphological variation in Orange River yellowfishes</b>	<b>21</b>
	<i>Roger Bills, Martin Villet &amp; Nick Jones</i>	
3.1.1	Introduction	21
3.1.2	Materials, methods and initial field results	23
3.1.3	Results	27
3.1.4	Discussion and recommendation	32
3.1.5	References	33
3.1.6	Appendix	34
<b>3.2</b>	<b>Allozyme study of <i>Labeobarbus aeneus</i>, <i>L. kimberleyensis</i> and their hybrids</b>	<b>45</b>
	<i>Herman van der Bank &amp; Gina Walsh</i>	
3.2.1	Abstract	45
3.2.2	Introduction	45
3.2.3	Materials and methods	46
3.2.4	Results and discussion	49
3.2.5	Conclusions	51
3.2.6	References	51
<b>3.3</b>	<b>Mitochondrial DNA variation of <i>Labeobarbus aeneus</i> and <i>L. kimberleyensis</i></b>	<b>53</b>
	<i>Paulette Bloomer</i>	
3.3.1	Abstract	53
3.3.2	Introduction	53
3.3.3	Materials and methods	55
3.3.4	Results and discussion	58
3.3.5	Conclusions	66
3.3.6	References	66
3.3.7	Appendix	
<b>3.4</b>	<b>Summary of project timeline</b>	

## 1. SUMMARY REPORT

### 1.1 Executive summary

The relationships within and between two yellowfish species, *Labeobarbus aeneus* (smallmouth yellowfish) and *L. kimberleyensis* (largemouth yellowfish) from the Orange-Vaal system were investigated through three independently conducted studies of the same material collected from the Sak River (the type locality of *L. aeneus*), the upper Orange River at Aliwal North and the lower Orange River at Pella and Onseepkans.

Previously suggested body measures were used for field identification and this was followed by initial measurement of 53 features to investigate the **morphological variation** within and between the two species. This set of measurements was refined to 31 which were used for intensive analysis. There were consistent morphological differences between the two species from Aliwal North and the lower Orange. Although the two species are closely related, these morphological differences presumably result from use of slightly different habitats and resources within the river. Thus *L. kimberleyensis* and *L. aeneus* are morphologically distinct and identifiable using several features e.g. mouth position, mouth size, eye to preopercular groove distance, colouration, interorbital width. *Labeobarbus kimberleyensis* specimens were morphologically similar in the upper and lower Orange sites. In contrast the two *L. aeneus* populations were morphologically different from one another. The most obvious differences were that the lower Orange *L. aeneus* had significantly deeper bodies and longer fins. The lower Orange River, as well as being a much bigger river than the upper reaches at Aliwal North, provides a much wider variety of habitats which may account for the observed morphological variation.

**Allozyme analyses** were done of *L. aeneus* and *L. kimberleyensis* samples from the above mentioned sites as well as from the Vaal River and using *L. polylepis* from the Elands System, as an outgroup. Ten enzymes were screened for variation among the specimens. No diagnostic genetic markers (i.e. that were reported previously by other researchers) were recorded in this study between the three *Labeobarbus* species. Since these data point to introgressive hybridisation, it will be necessary in future to examine these yellowfish by combining traditional morphometrics with other parameters such as genetic and parasitological markers to confidently identify these fish. It appears that genetically impure species occur at most of these localities. Some genetically pure individuals were observed from the lower Orange raising the conservation status of this region. The most recent study indicates that allozyme analyses are not accurate anymore to differentiate between the taxa, and other molecular techniques should be employed in order to address this problem.

The **mitochondrial DNA (mtDNA) study** extended the previously conducted pilot study through an analysis of control region alleles among the samples from the above mentioned sites. A pilot study of variation within the KwaZulu-Natal scaly (*L. natalensis*) was used to provide a different perspective for the interpretation of the Orange-Vaal variation. In addition, control region sequences were generated for the two other yellowfish species in the smallscaled group (*L. capensis* and *L. polylepis*) in an attempt to

understand the phylogenetic relationships within this group of closely related yellowfishes. A small number of DNA sequences of the protein coding mtDNA cytochrome *b* gene was also done for comparison with previously reported sequences of related species (within *Labeobarbus*, *Varichorinus*, *Capoeta* and *Barbus*). An approximate rate of change in this gene was used to date the radiation of smallscaled yellowfish.

Based on the results of the morphological, allozyme and mitochondrial DNA studies, we recommend that:

- Immediate conservation action should include: No movement of any yellowfish species.
- Given the morphological and genetic distinction of the lower Orange, this region should be managed and protected as a separate conservation unit. This region would also be an ideal location for intensive ecological, morphological, parasitological and genetic studies.
- Field observations showed that *L. kimberleyensis* was significantly less abundant than *L. aeneus*. Therefore *L. kimberleyensis* would probably benefit from enforcing the non-use of gill nets, protected areas where no fishing of any form occurs (these should include suitable spawning beds and nursery habitats) and encouraging all anglers to return all *L. kimberleyensis* caught alive.
- This study should form the basis of ongoing research into the phylogenetic relationships, ecology and behaviour of Orange-Vaal yellowfish.
  - From a management point of view a better understanding of the use of habitats by *Labeobarbus* species is crucial. In particular radio telemetry projects looking at habitat may give some insights into the biology of the species as well as the observed variation within and between the species.
  - The basis for the morphological differences within *L. aeneus* and between what is currently considered as *L. aeneus* and *L. kimberleyensis*, should be investigated.
  - More sensitive genetic markers should be developed to study gene flow within the Orange-Vaal system. For such an investigation, as much detail as possible should be recorded regarding the sites of collection as well as features of the specimens. However, the analysis should be conducted blind, with no prior assignment of specimens to species. Once the genetic analyses have been conducted, the results can be correlated with field observations and conclusions drawn regarding the species status of particular individuals.
  - Practices that may potentially transfer yellowfish between systems should be identified and their impact assessed.

## 1.2 Background and aims

### 1.2.1 The genus *Labeobarbus* (note that whenever the abbreviation “L.” is used throughout the report, it refers to the genus *Labeobarbus*)

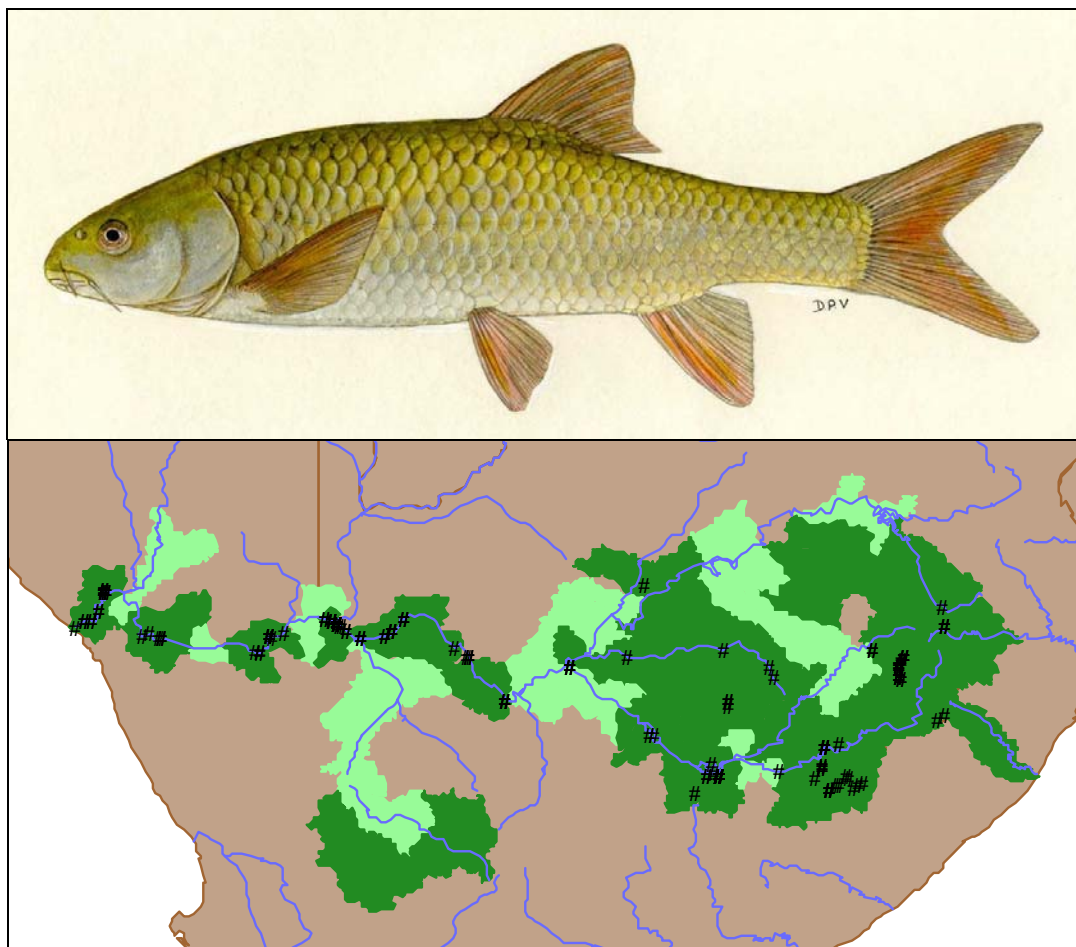
The southern African primary freshwater fish fauna are dominated by cyprinids (74 or 30% of the total), many of which until recently described within the genus *Barbus* (Skelton 2001). Relationships among the 500 African species within the genus are not well understood due to a limited number of morphological characters that distinguish the different species from each other (Skelton 1988, Berrebi *et al.* 1996). Based on ploidy level (i.e. the number of sets of chromosomes; Berrebi *et al.* 1996) and recent DNA-based studies the group has been re-organised (Machordom & Doadrio 2001; Tsigenopoulos *et al.* 2002). Based on these data sets the large African hexaploid (150 chromosomes) species form a monophyletic group (i.e. they have a single common ancestor) and have been reclassified within the genus *Labeobarbus*.

These species, commonly known as yellowfishes, are large and relatively long-lived cyprinids of many African rivers and lakes (Skelton, 2001). The genus is characterised by large size (some species over 20kg), hexaploidy, parallel striations on scales and spiny, unserrated primary dorsal fin rays. Certain yellowfishes exhibit considerable morphological variation both between and within populations particularly with regard to mouth morphology. Yellowfish with horny lips for chiselling algae and invertebrates off rocks and thick, rubbery lips for foraging in cracks between rocks are typically found together. This variation is associated with varying feeding behaviours and individual fish morphology can change if their environment changes.

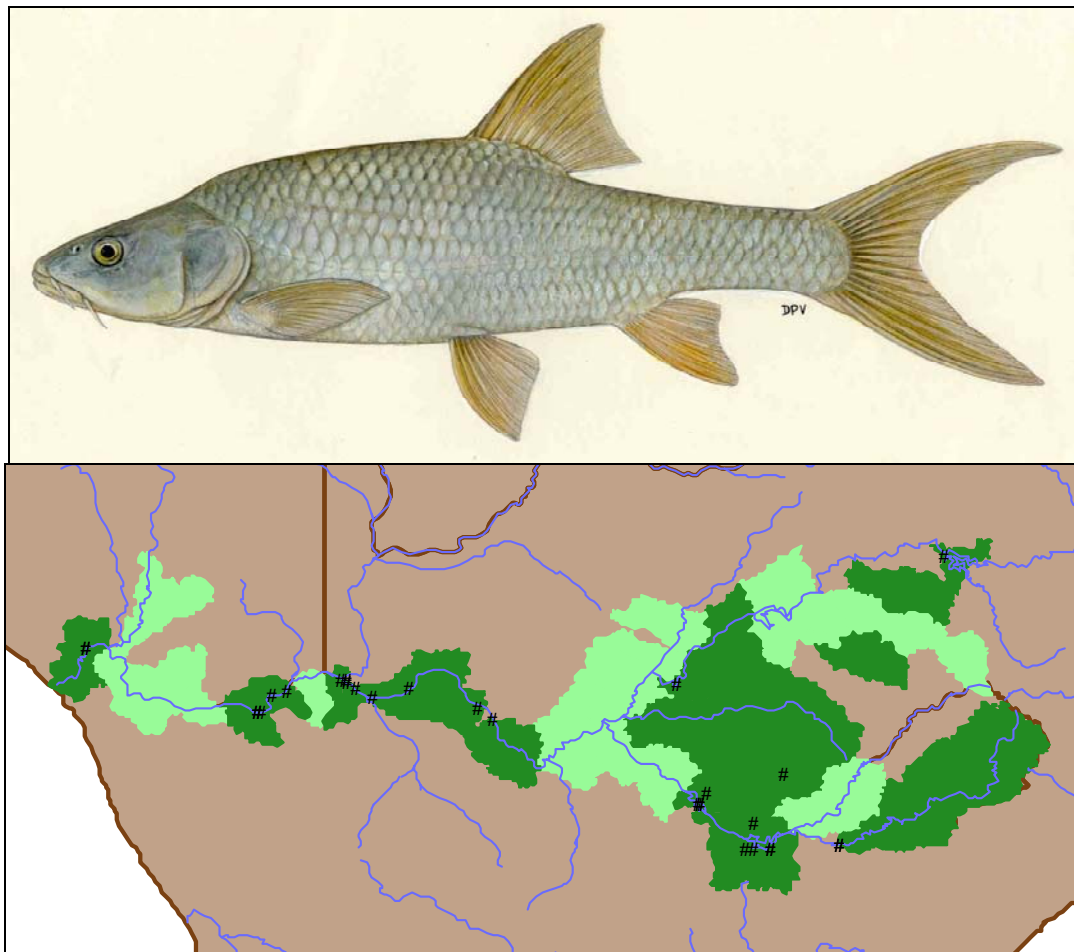
Relationships between the southern African yellowfish species are still uncertain but there appears to be two groups, namely the largescaled (*L. codringtonii*, *L. marequensis*) and the smallscaled group (*L. polylepis*, *L. natalensis*, *L. capensis*, *L. kimberleyensis* and *L. aeneus*). The evolution of the southern African yellowfishes, especially the so-called smallscaled group, is centered on the Orange River basin (Jubb 1964). It has been proposed that these five species have diversified from a common ancestor that invaded the Orange River basin from the north during the mid-Pliocene (2-3 million years ago; Skelton 2001). DNA-based studies proposed that *Labeobarbus* had a recent origin but it is as yet unclear whether they had an African or non-African ancestor (Tsigenopoulos *et al.* 2002). *Labeobarbus capensis* (endemic to the Clanwilliam Olifants River in the Western Cape), *L. natalensis* (widespread in KZN rivers from the Mkuze south to the Eastern Cape border) and *L. polylepis* (highveld reaches of southern Limpopo, Incomati and Phongolo Rivers) have more restricted distributions with little or no natural geographic overlap with other smallscaled *Labeobarbus* species. In contrast, *L. aeneus* and *L. kimberleyensis* are both endemic to the Orange-Vaal system, are widespread and overlaps extensively in terms of their distributions.

### 1.2.2 Orange River yellowfishes, their distributions and principal differences

The smallmouth yellowfish (*L. aeneus*, Fig. 1) is typically the more abundant and widespread Orange River yellowfish. It occurs in the mainstream sections of the Orange and Vaal Rivers and also penetrates high up into smaller tributary sub-systems. In contrast the largemouth yellowfish (*L. kimberleyensis*, Fig. 2) appears to be confined to the mainstream sections on the Vaal and Orange Rivers. It also appears more common in the Vaal system than the Orange River.



**Figure 1.** *Labeobarbus aeneus* (from Skelton 2001) and a distribution map (dots = museum records, dark green = areas of known occurrence, light green = areas of suspected occurrence).



**Figure 2.** *Labeobarbus kimberleyensis* (from Skelton 2001) and a distribution map showing museum records (dots = museum records, dark green = areas of known occurrence, light green = areas of suspected occurrence).

The morphological distinction between these species has been much debated; some authors reported clear differences (Jubb 1964, Skelton 2001), while others suggested that the distinction is difficult (Eccles 1986, Oellermann 1988). The species exhibit some life history differences in terms of feeding and associated gut morphology (Mulder 1973, Tomasson 1973, Eccles 1986), longevity (Tomasson 1973), age at sexual maturity, breeding male characteristics and spawning period (Mulder 1973), and temperature tolerance (Tomasson 1973). There are reports of hybridisation between the two species (Gaigher 1976, Eccles 1986, Mulder 1986). This may potentially be as a result of extensive habitat modification especially in the flow regime of the system. The Orange-Vaal System is highly regulated with a large number of impoundments (large dams and many small farm dams) as well as weirs, bridges and drifts along its course, and extensive agricultural and industrial use of its water (Skelton & Cambray 1981). The direct impacts on yellowfish include reduction of river flow, barriers to migration and movement of fish for recreational purposes. Confirmation of hybridisation and the extent thereof have, however, never been established.



### 1.2.3 The need for the identification of conservation units and the Orange-Vaal yellowfish genetics pilot study

Both species have been actively promoted as angling species in South Africa. Although their enhanced socio-economic value will be extremely beneficial for their long-term conservation, there is a need for sustainable management of the different populations. De Villiers (2000) indicated that a large sport-fishery is developing but suggested that populations should be managed in such a way that stocking with hatchery fish would not be necessary and that stocking in dams should only be considered within the natural distribution range of a particular species. A pilot study of the mitochondrial DNA (mtDNA) variation of the two species (Bloomer 2006) represented one of the aspects that needed to be integrated into a long-term conservation management plan, namely an assessment of the underlying genetic diversity in the two species and the identification of populations that should be managed separately.

As part of the pilot study, due to the geographic extent of the Orange-Vaal system, both species were sampled from sites that were as representative as possible of the whole distribution. Over a period of nearly a year, 84 largemouth yellowfish were collected from eight localities and 180 smallmouth yellowfish from approximately 12 sites. The analysis of mtDNA variation showed that it was not possible to clearly distinguish between *L. kimberleyensis* and *L. aeneus* based on the targeted mtDNA region. MtDNA only measure maternal inheritance patterns and the observed results therefore indicated that the two species either speciated very recently (with too few generations to ensure separation of their mtDNA lineages), that there is hybridisation between the two species, or that there is in fact only a single species with two morphotypes. In order to distinguish between these possibilities it was recommended that additional investigatory parameters such as allozymes (measuring both maternal and paternal inheritance patterns) and morphological variation in conjunction with DNA based analyses should be used.

### 1.2.4 Aims

The follow-up study broadly addressed the following aims:

- Determination of differentiation between largemouth yellowfish (*L. kimberleyensis*) and smallmouth yellowfish (*L. aeneus*) based on morphology, allozymes and DNA analysis.
- A critical evaluation of possible hybridisation between the two species using the various methods.
- Formulation of recommendations for future research and for conservation management of the two species in the light of the results.

The close relationships between the ‘southern’ *Labeobarbus* raises a host of taxonomic, biogeographic and conservation issues. Some of these issues have been brought to the attention of conservationists due to (a) the recent interest in angling for yellowfishes and (b) the impacts of inter-basin water transfer schemes (IBWT’s). Both angling and IBWT’s can result in the mixing of yellowfish populations from widely separated tributary systems and even different systems. We examined some of these issues relating to yellowfishes of the Orange River. The system is the largest in the region, it is fragmented biogeographically and has two indigenous yellowfishes present. We asked the following questions.

- What is the extent of variation within and between *L. aeneus* and *L. kimberleyensis* based on morphology, allozymes and mtDNA?
- Is there any evidence to indicate hybridisation between the two Orange River yellowfishes?
- Are there differences between populations of the same species in different parts of the Orange River system?
- Will current diversity patterns be affected by mixing of fishes from different tributary sub-systems?

The scope of this project was to investigate these questions using two widely separated populations of large and small-mouth yellowfishes in the Orange River system. The sites chosen were the upper Orange River at Aliwal North (Eastern Cape) and the lower Orange River at Onseepkans and Pella Drift (Northern Cape). We used a multi-disciplinary approach comparing morphological and genetic diversity between the species and the populations from these sites. The choice of populations to study was critical as one needs reference populations of the pure species in order to determine whether hybridisation is occurring. This was problematic in the case of *L. kimberleyensis* as there are no instances, to our knowledge, of areas where one would only find this species and not also *L. aeneus*. There are, however, areas where only *L. aeneus* can be collected, such as the Sak River that is also the type locality from which this species was first described.

### 1.3 Rationale for choice of investigatory methods

#### 1.3.1 Why a multi-disciplinary approach?

Speciation is a dynamic and complex process and the timeframe since the split of two (or more) new forms from an ancestor, as well as the underlying mechanisms involved in the split, will influence our ability to clearly distinguish the two forms. The longer ago such a split occurred the more likely it will be that all investigatory methods will yield the same clear result. Also, for two species to remain distinct, the period following the split must involve the development of mechanisms that will prevent them from interbreeding in future, such as for example, different breeding seasons and behaviours, physical isolation or complete reproductive incompatibility. Smallmouth and largemouth yellowfish are largely overlapping in distribution and even though there is a slight shift in their breeding season and apparent differences in their preferred habitat, external fertilization coupled with a naturally unpredictable and changing environment (i.e. flow regime of rivers) could lead to many opportunities

for contact and potential mixing of the forms and their gametes (eggs and sperm). Basing decisions regarding separate species status solely on a single method of analysis is usually not recommended except in cases of old speciation events and where subsequent natural habitat fragmentation have allowed for a long period of independent existence. We therefore followed a widely advocated approach of using independent methods to analyse the same samples and to use all the information in drawing conclusions (Crowe 1999). Each individual method has its own strengths and weaknesses and we aimed to critically evaluate our results to allow us to make sound recommendations for future research and management.

### 1.3.2 Morphology/Morphometrics

There is a need to do accurate morphological measures and counts on fishes sampled so that the differences between the two species are clearly described. Ultimately people need to identify these species accurately in the field and these identifications will be based on morphology and not genetics or parasites. There needs to be an understanding of if and how the morphology is linked with genetic and parasite differences between the species. We also need to understand morphological changes associated with any hybrids (e.g. Hardap Dam) and mono-species (e.g. Sak River) populations. These morphological determinations need to feed back to field workers so that they can accurately identify the two species in the most efficient ways. We aimed to do around 15 to 20 measures and counts to determine the best features needed to distinguish between the two species. The intention was to end up with less than five measures that field workers will need.

The word morphometrics is derived from the Greek words “morpho” meaning shape and “metron” meaning measurement. There are many definitions of the word and numerous forms of morphometric analysis in biology. In the present case we used morphometrics to describe aspects of yellowfish external body shape. We have measured certain features of the yellowfishes, using clearly identifiable points e.g. the origin of the dorsal fin, and have made some meristic counts e.g. the number of dorsal fin rays. These data have then been log transformed in an attempt to reduce the impact of shape change due to increasing body size (allometry). The log-transformed data have then been subjected to Principal Component Analysis (PCA), which is the most widely used multivariate statistical analysis method. PCA is the most appropriate method when the identities of individuals or groupings are uncertain or not known. A good review of the subject, giving an overview of strengths and weaknesses of the various methods is given in Schaefer (1991).

Morphological variation in yellowfishes is discussed in Crass (1964), Jubb (1967) and Skelton (2001). Variation in certain features can be considerable even within populations and this is exacerbated when populations from different river catchments are compared. The degree of variation exhibited by yellowfishes is a factor in why so many synonyms of certain species exist (Table 1, *L. aeneus* (3), *L. natalensis* (11), *L. marequensis* (13)).

**Table 1.** Synonyms recognized within three yellowfish species.Labeobarbus aeneus

*Cyprinus aeneus*, Burchell 1822  
*Barbus gilchristi*, Boulenger 1911  
*Barbus bolubi*, Steindachner 1894  
*Barbus mentalis*, Gilchrist & Thompson 1913

Labeobarbus marequensis

*Barbus brucei*, Boulenger 1907  
*Barbus cookei*, Gilchrist & Thompson 1913  
*Barbus dwaarsensis*, Gilchrist & Thompson 1913  
*Barbus fairbairnii*, Boulenger 1908  
*Barbus gunningi*, Gilchrist & Thompson 1913  
*Barbus inermis*, (Dangila) Peters 1852  
*Barbus marequensis*, (Cheilobarbus) Smith 1841  
*Varicorbinus nasutus*, Gilchrist & Thompson 1911  
*Barbus rhodesianus*, Boulenger 1902  
*Barbus sabiensis*, Gilchrist & Thompson 1913  
*Barbus sector*, Boulenger 1907  
*Barbus swierstrae*, Gilchrist & Thompson 1913  
*Barbus victoriae*, Boulenger 1908  
*Labeobarbus zambezensis*, Peters 1852

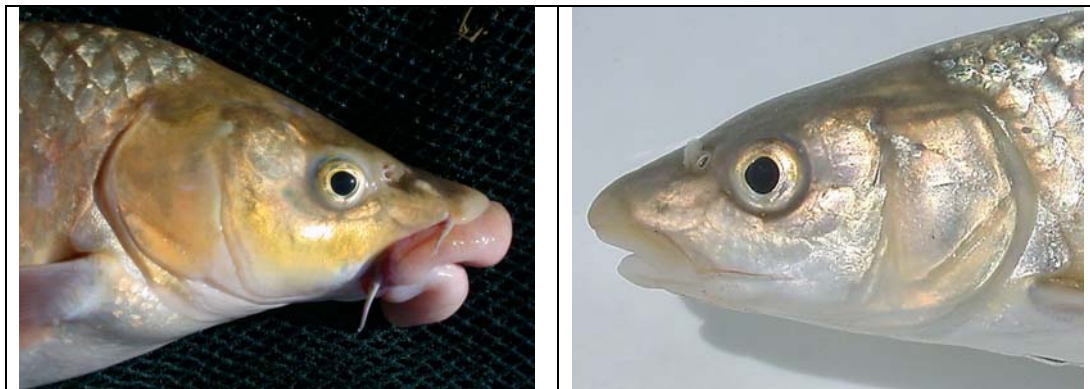
Labeobarbus natalensis

*Labeobarbus aureus*, Cope 1867  
*Barbus bowkeri*, Boulenger 1902  
*Barbus dendrotrachelus*, Fowler 1934  
*Barbus grouti*, Fowler 1934  
*Barbus lobocheilus*, Boulenger 1911  
*Barbus marleyi*, Fowler 1934  
*Barbus mfangosi*, Gilchrist & Thompson 1913  
*Barbus natalensis*, Castelnau 1861  
*Barbus robinsoni*, Gilchrist & Thompson 1913  
*Barbus stigmaticus*, Fowler 1934  
*Barbus tugelensis*, Fowler 1934  
*Barbus zuluensis*, Gilchrist & Thompson 1913

In particular, variation of mouth form may be extreme and has attracted the attention of most studies examining yellowfish morphology. Typically thin-lipped forms dominate populations yet varying numbers of specimens with swollen mental lobes, thick upper and lower lips and intermediates may be present in populations. It is considered that the thin-lipped forms have the ability to forage in a greater variety of circumstances while the thick-lipped individuals are rather specialized forcing the rubbery lips into rocky crevices and extracting invertebrates. Thick-lipped forms placed in mud-substrate ponds in Lydenberg reverted to the typical thin-lipped morphs after about one year (Jubb 1967). Associated with the different mouth forms are a series of morphological changes to the head muscles and overall profile and behavioural changes (foraging methods).

In the material examined from the lower and upper Orange for the present study thin-lipped forms dominated. There were some specimens with mental lobes and fewer with fully developed thick upper

and lower lips (Fig.3). Samples were analysed randomly and lip forms are not indicated in the PCA plots.



**Figure 3.** Different lip forms observed among Orange-Vaal yellowfishes. Typically thin-lipped forms dominate populations yet varying numbers of specimens with swollen mental lobes, thick upper and lower lips and intermediates may be present in populations.

### 1.3.3 Allozymes

Molecular genetic techniques in fisheries research have increased dramatically over the past several years. The molecular technique mainly applied to population genetic research, is protein (allozyme) electrophoresis. The principle of electrophoresis is based on the fact that any charged ion/group will migrate when placed in an electric field. Proteins and enzymes carry a net charge at any pH, other than their own, and will migrate at a rate depending on the ratio of its charge to mass. A gel [e.g. heated starch in a buffer] is poured into a mold and left to cool and to set; fish samples are ground separately for each individual in a fluid to break the cells and to release the enzymes; filter paper is dipped in it to absorb the enzyme mixture; it is placed in the gel and an electric current is applied to start the above-mentioned migration process (depending on 1) the concentration or starch to buffer ratio, which determines the pore size of the gel, 2) the charge and 3) pH of the enzymes). Histochemical staining follows after a few hours. The bands (different forms of enzymes encoded by different alleles at the same locus) are called allozymes. Fixed allozyme differences (100% different) for different species (e.g. only Esterase-1\*100 bands for *L. kimberleyensis* compared to only Esterase-1\*95 bands for *L. aeneus*; see Fig. 1 of section 3.2.3) are a very useful diagnostic tool to identify the species on a routine basis. Hybrids between the species will have both bands. This technique has the advantage that it is technically simple, very informative, the method allows for quick processing time, it is less expensive than other methods, and allozyme data constitute the largest existing genetic data set for many organisms (see Park & Moran (1995) for a comparison of various methods). The method is useful for defining genetic markers for stock identification (by documenting differences in protein allele frequencies between stocks), and differentiation. It can also be used to estimate the effective number of individuals exchanged between generations (to determine the efficiency of gene flow between

populations and taxa), and average heterozygosity (to counter the effects of allele fixation and differentiation between populations). It is, therefore, possible to establish if various individuals should be considered as part of a single, large genetic population, different species, hybrids, or not. Allozyme studies by Van Vuuren *et al.* (1989) identified diagnostic loci, with fixed allele differences for the above-mentioned species. Our aim was to report variation and differentiation at the polymorphic loci identified by Van Vuuren *et al.* (1989) in muscle and liver samples for various populations. Mulder (1986) analysed seven enzymes (10 loci) of 33 *L. kimberleyensis* from the Vaal Dam, 62 *L. aeneus* from the Vaal River and 61 mixed stocks between them for Hardap Dam. He could not distinguish between the species. Three years later, Mulder (1989), reported results for 40 and 50 individuals of *L. kimberleyensis* and *L. aeneus* respectively from the Vaal River at 29 loci. He found fixed allele differences at four loci (AK-1, MPI-1, LT-1 and -2; MPI-1 was reported as being “diagnostic”). Fixed allele difference at only one locus is sufficient to differentiate between species.

#### 1.3.4 Mitochondrial DNA

Based on numerous studies published on freshwater fish species, we selected the mitochondrial DNA (mtDNA) control region as genetic marker for the pilot and follow-up studies of genetic variation of yellowfishes. Mitochondrial DNA is located outside the cell nucleus (which contains all the chromosomes) and is inherited separate from the other genetic material. Another unusual feature of mtDNA is that it is maternally inherited in most animal species, i.e. it is only passed on from the female parent to all the offspring (males and females). There is therefore no mixing of maternal and paternal genetic variants (alleles) of particular genes. The mtDNA molecule contains 37 genes with specific functions and a control region. The latter region does not code for a specific molecular product but is not entirely nonfunctional. Several very important signals for the normal functioning of the mtDNA molecule are contained in this region. Compared to the 37 genes, however, the control region evolves quite rapidly and it allows one to record the pattern of changes within and between different species. It can even resolve differences between different populations within the same species, depending on the dynamics of the connection between them. Although mtDNA has been widely applied in the study of fish populations, it also has limitations. Because all the genes are inherited together as a single circular molecule, all the genes represents one marker of the particular history one wishes to uncover. Also, due to the maternal inheritance, the mtDNA only reflects the female genealogy which is not always representative of the species' history. The latter is true especially in cases of hybridisation where it is possible, over many generations of back-crossing, for one species to possess the mtDNA of another (termed introgressive hybridisation). Another limitation of mtDNA relates to effective population size, i.e. the number of breeding individuals in a population. In population genetic terms this is the number of alleles that can be drawn from to create a next generation during reproduction (Hedrick 2000). For any particular gene in the nuclear DNA, offspring will inherit two alleles, one from each parent. The number of alleles that is thus available to be inherited will be four. In contrast to this, for any mtDNA allele, the number of alleles that can be inherited will only be one (i.e. that of the mother). This means that mtDNA has a smaller effective population size than nuclear DNA and this will over many generations of inheritance affect the pattern of variation. Specific alleles will become fixed much faster

than nuclear DNA alleles and many alleles will go extinct. For comprehensive reviews on mtDNA and its utility consult Moritz *et al.* (1987), Avise (2000) and Zhang & Hewitt (2003).

Given the current accepted separate species status of largemouth and smallmouth yellowfish we expected clear mtDNA differences between them and given the geographic scale of the Orange-Vaal system, we did not expect to find gene flow among all areas within the system for each of the two species.

## 1.4 Summary of results

### 1.4.1 Morphology

Variation in overall body form can be seen in the spread of individual specimens on the PCA plots (see section 3.1.6 Appendix Figures I-V). A degree of this variation, particularly on PCA1, is due to varying specimen size. We analysed the entire range of sizes we collected and many features are allometric i.e. they change in proportion with changing body sizes. An ANOVA plot of PCA2 shows no overlap between *L. aeneus* and *L. kimberleyensis* (Figure VI).

Variation in individual features can be seen on the range bars on the ANOVA plots (Figures VI-XIII). Where range bars overlap these features would not be valuable in distinguishing between 'groups'.

#### Posterior orbit to pre-opercular groove distance.

This is one of the main features used by Skelton (2001) to distinguish between *L. aeneus* and *L. kimberleyensis*. Firstly, there is no overlap in this feature between the two species. There is also no overlap between the two *L. kimberleyensis* samples, however, the two samples were of markedly different sizes and this feature is allometric. Consequently, in very small specimens of *L. kimberleyensis* this feature may be uninformative for distinguishing between the species.

#### Inter-orbital width.

This feature is not indicated in keys for distinguishing between the species (Skelton, 2001). Eye positions and head profiles are discussed by Jubb (1967). Despite a degree of variation in eye size within species and at different sites there is no overlap between the species for inter-orbital width. The difference in eye position between the two species is noticeable and presumably associated with varying foraging behaviour. *Labeobarbus kimberleyensis* is a fish predator catching prey directly ahead of it and perhaps above it hence its dorsally positioned eyes. *Labeobarbus aeneus* largely feeds on aquatic invertebrates and has more laterally positioned eyes. Variation in interorbital distance between the populations of each species could be attributed to varying eye size itself associated with overall body size (larger individuals have proportionately smaller eyes) and water clarity.

### Lower Jaw length

The length of the lower jaw is typically much longer in *L. kimberleyensis* than in *L. aeneus*. Very crudely this is indicated by the determination of a terminal mouth or sub-terminal/inferior mouth. There is no overlap between the two species in the ANOVA plot although there is considerable variation in individual populations. The feature is actually very difficult to measure as the complex of bones making up the lower jaw are wrapped in muscles and it is sometimes difficult to determine the exact posterior point of the bone in fixed specimens. Accurately determining this feature in live specimens is very simple as you can easily move the jaws and see the posterior articulation point.

Some good diagnostic features for determining species were not measured and included in our analyses e.g. the position of the lower jaw (terminal or sub-terminal) and colouration.

Non-key features do show overlap between species and populations as are shown in the ANOVA plots. In this particular analysis *L. aeneus* from the lower Orange region stands out as the most frequently different with no or little overlap in features examined.

To conclude:

- There were consistent morphological differences between the two species from Aliwal North and the lower Orange. Although the two species are closely related, these morphological differences may result from use of slightly different habitats and resources within the river. Thus *L. kimberleyensis* and *L. aeneus* are morphologically distinct and identifiable using several features e.g. mouth position, mouth size, eye to preopercular groove distance, colouration, interorbital width.
- *Labeobarbus kimberleyensis* specimens were morphologically similar in the upper and lower Orange sites. In contrast the two *L. aeneus* populations were morphologically different from one another. The most obvious differences were that the lower Orange *L. aeneus* had significantly deeper bodies and longer fins. The lower Orange River, as well as being a much bigger river than the upper reaches at Aliwal North, provides a much wider variety of habitats which may account for the observed morphological variation.
- During the course of our collections it was obvious that *L. kimberleyensis* was significantly less abundant than *L. aeneus*. The levels of fishing may be an important impact upon larger specimens of both species. There were reports of extensive use of gill nets in the lower Orange. In the Vaal and upper Orange the numbers of people angling is also very high in certain localities. *Labeobarbus kimberleyensis* would probably benefit from enforcing the non-use of gill nets, protected areas where no fishing of any form occurs (these should include suitable spawning beds and nursery habitats) and encouraging all anglers to return all *L. kimberleyensis* caught alive.



### 1.4.2 Allozymes

- Fixed allele differences were obtained at the Esterase-1 locus for the first six individuals each of *L. aeneus* and *L. kimberleyensis* at Onseepkans. Subsequent analyses of the rest of the lower Orange population revealed allele frequencies of 0.750 and 0.952 for the Esterase-1\*100 allele and 0.250 and 0.048 at Esterase-1\*95 for these species respectively. All of the other individuals analysed had only the former allele.
- No fixed differences could be obtained for these species at any of the loci in the present study. In previous studies fixed differences were reported between the species. The differences in results can, therefore, be attributed to introgressive hybridisation (the exchange of genes between evolutionary lineages due to backcrossing). Although the allozyme analysis was useful in the past (e.g. for F<sub>1</sub> hybrids), it is not anymore due to backcrossing in the subsequent generations.
- This study indicates that allozyme analyses are not accurate anymore to differentiate between the taxa, and other molecular techniques should be employed in order to address this problem.

### 1.4.3 Mitochondrial DNA

- Twenty two unique maternal alleles were identified among 92 Orange-Vaal samples; some alleles are shared between many individuals and were recorded from several sites whereas other alleles occurred at low frequencies.
- In agreement with the pilot study, *L. aeneus* and *L. kimberleyensis* from the Sak River, upper Orange (Aliwal North) and lower Orange (Onseepkans and Pella Drift), shared some maternal alleles. This could be due to the presence of shared ancestral alleles dating to before the split between the two closely related species or could indicate introgressive hybridisation of *L. aeneus* alleles into *L. kimberleyensis*.
- Variation within Orange-Vaal yellowfish is much lower than that observed in *L. natalensis* (the KwaZulu-Natal scaly) based on a small pilot investigation of variation in the latter species. Enough time had elapsed for *L. natalensis* from currently geographically isolated rivers, to develop differences in their mtDNA. With the exception of mtDNA alleles in the lower Orange, the remainder of the lineages within *L. aeneus* and *L. kimberleyensis* indicate a recent rapid spread of a few alleles throughout the system.
- Some of the *L. aeneus* from the lower Orange have more genetically distinct alleles and this area should be investigated in greater depth and treated as a separate conservation unit.

## 1.5 Conclusions and Recommendations

First, it is useful to consider the questions posed in section 1.2.4 above and to evaluate where we stand in answering them given the results of the present investigation:

### 1. What is the extent of variation within and between *L. aeneus* and *L. kimberleyensis* based on morphology, allozymes and mtDNA?

The morphological analysis detected distinct differences between *L. aeneus* and *L. kimberleyensis* but also reported considerable morphological variation especially within *L. aeneus*. Although the principal component analysis showed a lack of overlap in features between the species (see figs. IV and V in section 3.1.6), there is a lot of ‘scatter’ within each of the species and perhaps this variation is not indicative of only two distinct entities. The basis of the morphological variation should be assessed. The allozyme results failed to detect any fixed differences between *L. aeneus* and *L. kimberleyensis*, however, some individuals from the lower Orange showed consistent differences. More sensitive genetic markers should be developed to study nuclear DNA differentiation within and between the species. The mtDNA study found moderate levels of diversity among Orange-Vaal yellowfish. Some maternal lineages were shared between the two species and there was an indication of a past expansion in population size leading to the widespread distribution of a few closely related lineages throughout the system. Some *L. aeneus* individuals from the lower Orange are genetically distinct.

### 2. Is there any evidence to indicate hybridisation between the two Orange River yellowfishes?

From the current morphological analysis there does not appear to be a clear intermediate form that would be consistent with recent hybridisation. The allozyme results failed to detect any fixed differences between *L. aeneus* and *L. kimberleyensis* (and also with the more distantly related *L. polylepis*). This could be indicative of extensive introgressive hybridisation or too little resolution of the allozyme markers. The mtDNA data also suggested either hybridisation or a very close genetic relationship between the two species. Until the three data sets can be directly compared without prior identification of smallmouth or largemouth yellowfish in the analysis, it would be difficult to rule out hybridisation. Further research should be done to resolve this critical matter.

### 3. Are there differences between populations of the same species in different parts of the Orange River system?

Yes, especially within *L. aeneus*. In this instance all three data sets generally agreed that the lower Orange *L. aeneus* showed distinct differences from individuals of the remainder of the system. Additional samples were recently collected from this region and will be analysed as part of a more in-depth DNA-based genetic study. The lower Orange should be managed as a separate conservation unit.

#### 4. Will current diversity patterns be affected by mixing of fishes from different tributary sub-systems?

No artificial movement of yellowfishes should be allowed. If hybridisation is confirmed, the natural diversity patterns within these species have already been seriously affected. As a matter of urgency the extent of this impact should be documented and important conservation areas identified.

Given these results we **recommend** that:

- there should be no movement of Orange-Vaal yellowfish (and other yellowfish species) such as for stocking of dams and the impacts of water management practices such as IBWT's should be critically evaluated.
- the lower Orange should be treated as a separate conservation unit.
- further research should be undertaken to resolve the issues raised.

## 1.6 References

- Avise, J.C. 2000. *Phylogeography. The history and formation of species*. Harvard University Press, Cambridge MA.
- Berrebi, P., Kottelat, M., Skelton, P.H. & Rab, P. 1996. Systematics of *Barbus*: state of the art and heuristic comments. *Folia Zoologica* 45:5-12.
- Crass, R.S. 1964. *Freshwater Fishes of Natal*. Shuter & Shooter, Pietermaritzburg.
- Crowe, T.M. 1999. Species as multi-faceted entities. In: Proceedings of the 22<sup>nd</sup> International Ornithology Congress, Durban (Adams, N.J. & Slotow, R.H, eds.), BirdLife South Africa Johannesburg, pp. 1490-1495.
- DeVilliers, P. 2000. Name that yellowfish. *Flyfishing* Oct/Nov 2000: 32.
- Eccles, D.H. 1986. Development of gut in the South African cyprinid fish *Barbus aeneus* (Burchell). *South African Journal of Zoology* 21: 165-169.
- Gaigher, I.G. 1976. The reproduction of the *Barbus* cf. *kimberleyensis* (Pisces: Cyprinidae) in the Hardap Dam, South West Africa. *Zoologica Africana* 11(1): 97-110.
- Hedrick, P.W. 2000. *Genetics of populations*. 2<sup>nd</sup> edition. Jones and Bartlett Publishers, Sudbury, Massachusetts.
- Jubb, R.A. 1964. Freshwater fishes of southern Africa. 1. The Orange and South Coastal Drainage Basins. *South African Journal of Science* 60: 17-21.
- Jubb, R.A. 1967. *Freshwater Fishes of Southern Africa*. A.A. Balkema, Cape Town.
- Machordom, A. & Doadrio, I. 2001. Evolutionary history and speciation modes in the cyprinid genus *Barbus*. *Proceedings of the Royal Society London B* 268: 1297-1306.
- Moritz, C.C., Dowling, T.E. & Brown, W.M. 1987. Evolution of animal mitochondrial DNA: Relevance for population biology and systematics. *Annual Review of Ecology and Systematics* 18: 269-292.
- Mulder, P.F.S. 1973. Aspects of ecology of *Barbus kimberleyensis* and *Barbus holubi* in the Vaal River. *Zoologica Africana* 8: 1-14.
- Mulder, P.F.S. 1986. 'n Vergelykende morfometriese en elektroforetiese ondersoek van *Barbus aeneus* en *Barbus kimberleyensis*. MSc dissertation. Johannesburg: Rand Afrikaans University.
- Oellermann, L.K. 1988. The karyology and taxonomy of the southern African yellowfish (Pisces: Cyprinidae). MSc thesis, Rhodes University, Grahamstown, South Africa.

- Park, L.K. & Moran, P. 1995. Developments in molecular genetic techniques in fisheries. In: *Molecular Genetics in Fisheries* (Carvalho, G.R. & Pitcher, T.J., eds.), Chapman & Hall, London, pp. 1-9.
- Schaefer, S.A. 1991. Morphometric investigations in cyprinid biology. In: *Cyprinid fishes: systematics, biology and exploitation*. (Winfield, I.J. & Nelson, J.S., eds.), Chapman & Hall, London.
- Skelton, P.H. 1988. The distribution of African freshwater fishes. In: *Biologie et ecologie des poissons d'eau douce africains*. (Leveque, C., Bruton, M.N. & Ssentongo eds.), ORSTOM: Paris, pp. 65-91.
- Skelton, P. 2001. *Freshwater Fishes of Southern Africa*. Struik Publishers, Cape Town.
- Skelton, P.H. & Cambray, J.A. 1981. The freshwater fishes of the middle and lower Orange River. *Koedoe* 24: 51-66.
- Tomasson, T. 1973. The biology and management considerations of abundant large cyprinids in Lake Le Roux, Orange River South Africa. (Oral presentation) Annual meeting of American Society of Ichthyologists and Herpetologists.
- Tsigenopoulos, C.S., Rab, P., Naran, D. & Berrebi, P. 2002. Multiple origins of polyploidy in the phylogeny of southern African barbs (Cyprinidae) as inferred from mtDNA markers. *Heredity* 88: 466-473.
- Van Vuuren, N.G., Mulder, P.F.S., Ferreira, J.T. & Van der Bank, F.H. 1989. The identification of hybrids of *Barbus aeneus* X *Barbus kimberleyensis* and *Labeo capensis* X *Labeo umbratus* in Hardap Dam, SWA/Namibia. *Madoqua* 16(1): 27-34.
- Zhang, D.-X. & Hewitt, G.M. 2003. Nuclear DNA analysis in genetic studies of populations: practice, problems and prospects. *Molecular Ecology* 12: 563-584.

## 2. ACKNOWLEDGEMENTS

The research team acknowledges the financial and logistical contributions of AngloGold Ashanti, FOSAF and SAIAB. This work is based on research supported by the National Research Foundation. Any opinion, findings and conclusions or recommendations expressed in this material are those of the authors and therefore the NRF does not accept any liability in regard thereto.

Daksha Naran (then a PhD student of Rhodes University and SAIAB) is acknowledged for generating most of the molecular data for the pilot study report that have been incorporated in the follow-up study mitochondrial DNA analysis. Carel Oosthuizen and Isa-Rita Russo assisted with laboratory analysis.

We are indebted to the Yellowfish Working Group for their continued support throughout the duration of the study.

### 3. DETAILED SCIENTIFIC REPORT

#### 3.1 Morphological variation in Orange River Yellowfishes (Cyprinidae: *Labeobarbus*)

*Roger Bills<sup>1</sup>, Martin Villet<sup>2</sup> and Nick Jones<sup>2</sup>*

*South African Institute for Aquatic Biodiversity, Grahamstown; Dept of Zoology, Rhodes University, Grahamstown*

##### 3.1.1 Introduction

Yellowfishes (*Labeobarbus* spp.) are large and relatively long-lived cyprinids of many African rivers and lakes (Skelton, 2001). The genus is characterised by large size (some species over 20kg), hexaploidy (150 chromosomes), parallel striations on scales and spiny, unserrated primary dorsal fin rays. Certain yellowfishes exhibit considerable morphological variation both between and within populations particularly with regard to mouth morphology. Yellowfish with horny lips for chiselling algae and invertebrates off rocks and thick, rubbery lips for foraging in cracks between rocks are typically found together. This variation is associated with varying feeding behaviours and individual fish morphology can change if their environment changes.

The South African *Labeobarbus* appear to be a distinct sub-group comprising the following species: *L. aeneus* - Orange River endemic; *L. kimberleyensis* - Orange River endemic; *L. capensis* - Olifants River endemic; *L. natalensis* – widespread in Natal rivers from the Mkuze River south to Eastern Cape border; and *L. polylepis* – highveld reaches of southern Limpopo, Incomati and Phongolo Rivers. The relationship between this ‘southern’ group and other *Labeobarbus* remains to be determined.

The close relationships between the ‘southern’ *Labeobarbus* raises a host of taxonomic, biogeographic and conservation issues. Some of these issues have been brought to the attention of conservationists due to a) the recent interest in angling for yellowfishes and b) the impacts of inter-basin transfer schemes (IBT’s). Both angling and IBT’s can result in the mixing of yellowfish populations from widely separated tributary systems and even different systems. We examined some of these issues relating to yellowfishes of the Orange River. The system is the largest in the region, it is fragmented biogeographically and has two indigenous yellowfishes present - the largemouth yellowfish (*L. kimberleyensis*) and the smallmouth yellowfish (*L. aeneus*). We asked the following questions.

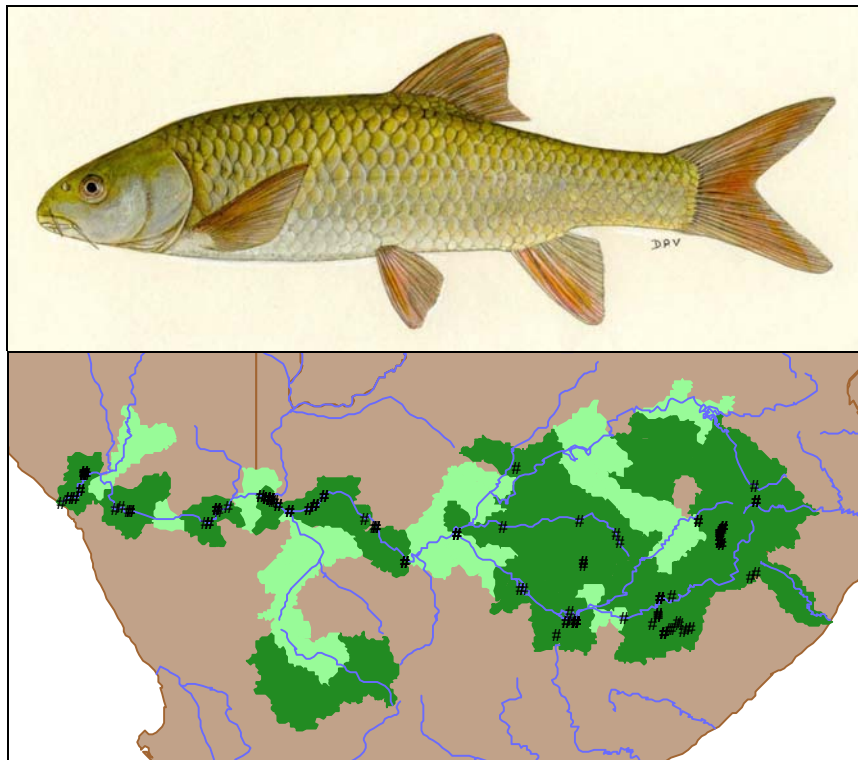
- Is there any evidence to indicate hybridisation between the two Orange River yellowfishes *L. aeneus* and *L. kimberleyensis*?
- Are there differences between populations of the same species in different parts of the Orange River system?
- Will current diversity patterns be affected by mixing of fishes from different tributary sub-systems

The scope of this pilot project was to investigate these questions using two widely separated populations of large and small-mouth yellowfishes in the Orange River system. The sites chosen were

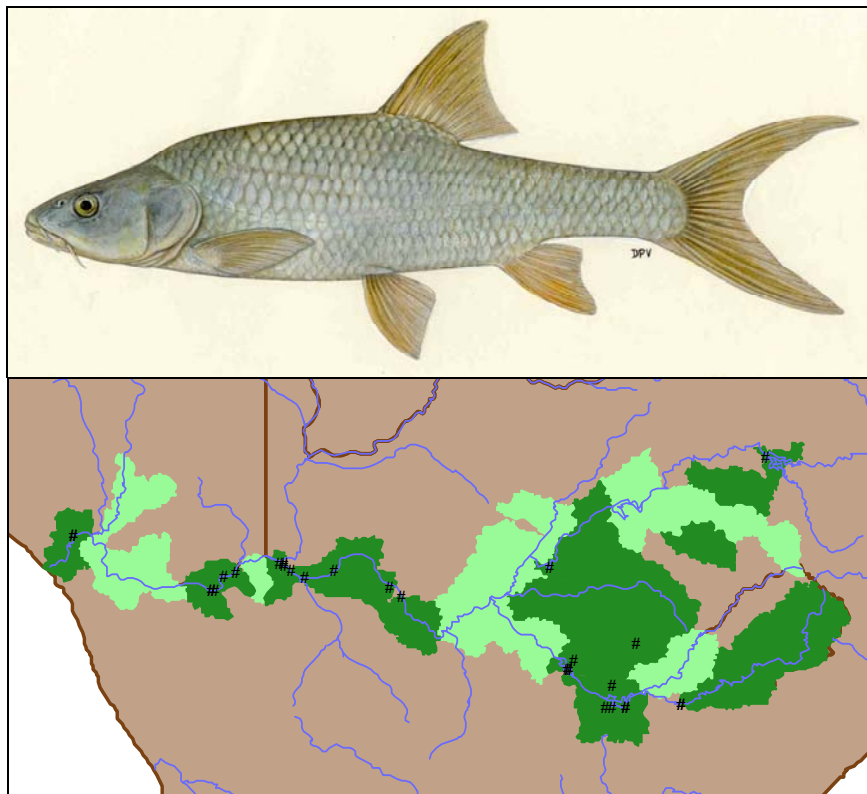
the upper Orange River at Aliwal North (Eastern Cape) and the lower Orange River at Onseepkans and Pella Drift (Northern Cape). Our approach was to compare the morphology between the two species and the populations from the two sites. A complimentary project (see sections 3.2 and 3.3) looked at genetic diversity using the same material.

Since this pilot project was conducted one of us (RB) has visited the lower Orange River in Namibia (from the Houms River - Orange River confluence (28° 51' 05" S 18° 36' 52" E) down to the Orange River mouth (28° 37' 47" S 16° 26' 37" E) during November 2006. Some data from this trip are also presented where considered relevant.

**Orange River yellowfishes and their distributions.** The smallmouth yellowfish (*L. aeneus*, Figure 1) is typically the more abundant and widespread Orange River yellowfish. It occurs in the mainstream sections of the Orange and Vaal Rivers and also penetrates high up into smaller tributary sub-systems. In contrast the largemouth yellowfish (*L. kimerleyensis*, Figure 2) appears to be confined to the mainstream sections on the Vaal and Orange Rivers. It also appears more common in the Vaal system than the Orange River.



**Figure 1.** *Labeobarbus aeneus* (from Skelton 2001) and a distribution map (dots = museum records, dark green = areas of known occurrence, light green = areas of suspected occurrence).



**Figure 2.** *Labeobarbus kimberleyensis* (from Skelton 2001) and a distribution map showing museum records (dots = museum records, dark green = areas of known occurrence, light green = areas of suspected occurrence).

### 3.1.2 Materials, methods and initial field results

**Sites.** Two collection regions were chosen on the basis of gaps in previous collections, observed genetic variation in earlier studies and perceived present upper limits of *L. kimberleyensis* in the upper Orange River. The regions chosen were the Orange River around Aliwal North and the lower Orange River (below Augrabies Falls) between Onseepkans and Pella Drift. Site photographs are in figures 3-7.

- **Aliwal North.** Specimens were collected at a single site in the upper Orange near Aliwal North at a weir about 1km upstream of the N6 road bridge, 30° 40' 45" S 26° 43' 11" E.

The site was the main channel of the river and all specimens of both species were collected in the shallow margins (<1.5m depth). The substrate ranged from mud (directly below the weir) to sand and gravel (200m downstream of the weir) with occasional large rocks. There was no complex rocky habitat or aquatic vegetation beds.

- **Lower Orange.** We collected at three sites: Onseepkans above the main road bridge ( $28^{\circ} 44' 31''$  S  $19^{\circ} 20' 07''$  E); Pella Drift about 500m above the pump station ( $28^{\circ} 57' 39''$  S  $19^{\circ} 09' 50''$  E); and Pella Drift about 500m below the pump station ( $28^{\circ} 57' 47''$  S  $19^{\circ} 08' 36''$  E).

At Onseepkans the Orange River is braided into several channels. We sampled in a single small channel where there were rocky habitats in fast flows. At Pella Drift the river was in a single channel and was much deeper ( $>3$ m depth in places). We sampled the deeper channels where habitats were rocky runs and rapids.



**Figure 3.** The collection site on the Orange River at Aliwal North ( $30^{\circ} 40' 45''$  S  $26^{\circ} 43' 11''$  E) (upstream view).



**Figure 4.** The collection site on the Orange River at Aliwal North ( $30^{\circ} 40' 45''$  S  $26^{\circ} 43' 11''$  E) (downstream view).





**Figure 5.** One of the collection sites on the lower Orange River at Pella Drift (lower site) ( $28^{\circ} 57' 47''$  S  $19^{\circ} 08' 36''$  E) (upstream view).



**Figure 6.** One of the collection sites on the lower Orange River at Pella Drift (upper site) ( $28^{\circ} 57' 39''$  S  $19^{\circ} 09' 50''$  E) (downstream view).



**Figure 7.** One of the collection sites on the lower Orange River at Onseepkans ( $28^{\circ} 44' 31''$  S  $19^{\circ} 20' 07''$  E) (upstream view).

**Collection methods and samples.** Fishes were collected using varied methods including a 5m seine net, electrofishing, gill nets and hook and line (baited with maize kernels soaked in aniseed and almond essence) (Appendix, Table I).

In the field fishes were collected in small numbers at a time and kept alive in drums. This allowed us time to be sure of identifications and to process material in an unhurried way. Muscle tissues were stored in large 10mm cryo-tubes for allozyme analyses and frozen in liquid nitrogen. Smaller samples were placed in eppendorf tubes in ethanol for DNA sequencing. Tissue samples were labelled and linked to their voucher specimens and all specimens were individually labelled. Fishes were preserved in 10% formalin in the field and large specimens were injected with formalin. On returning to SAIAB fishes were rinsed and transferred into 60% propyl alcohol for long-term storage. All specimens have been accessioned into the SAIAB fish collection and accession numbers for these voucher specimens are given below.

**Fish identifications.** Prior to the expedition *L. aeneus* and *L. kimberleyensis* in the SAIAB collection were examined and specimens keyed out using keys in Skelton (2001). Discussions about key features were also held with Professor Paul Skelton to ensure we understood the full range of variation within each species. The features we used to identify the two species in the field were a ratio of snout length and eye to pre-opercular groove distance, mouth size, mouth position and body colour (Table 1).

In the field we experienced no difficulty in identifying any fishes, even juveniles and did not revise any identifications on returning to the laboratory in Grahamstown. Although we had been informed that hybrids of *L. aeneus* x *kimberleyensis* existed we did not observe any potential hybrids.

**Table 1.** Features used in the field to distinguish Orange River yellowfishes.

Features	<i>L. aeneus</i>	<i>L. kimberleyensis</i>
Ratio: snout length / eye-preoperculum	1 or more	less than 1
Mouth position	Inferior or sub-terminal	terminal
Mouth gape	Medium	large
Colour	tinged with yellow	silver

**Morphological measures and analysis.** Initially, a pilot study measured 53 features of 10 specimens for each species and these data were analysed using Principal Component Analysis (PCA). From this initial analysis a smaller number (31) of features contributing significantly to factors were then selected for the larger study of morphological variation. We measured these features (see below) using Helios vernier callipers and measurements were made to 0.1mm. Raw measures were log transformed prior to analysis and the programme Statistica was used.

**Table 2.** Counts and measures used in analysing morphological variation between yellowfish species and populations.

<u>Meristics</u>	Caudal fin length (lower lobe) (CFLl)
Lateral line scale count (LL)	Anal fin base length (AFBL)
Lateral line to dorsal fin origin scale count (ScDL)	Dorsal fin base length (DFBL)
	Body depth (BD)
	Dorsal fin rays (DFR)
<u>Measures</u>	Pectoral fin length (PFL)
Preanal length (PAL)	Snout length (SnL)
Prepelvic length (PPvL)	Interorbital width (IOW)
Prepectoral length (PPcL)	Operculum to Preoperculum (O-PrO)
Caudal peduncle length (CPL)	Maximum anal spine length (MAXL)
Caudal peduncle depth (CPD)	Maximum dorsal spine length (MDSL)
Head length (HL)	Origin of Pectoral fin to Premaxilla (Opec – PM)
Head depth (HD)	Ventral caudal peduncle to dorsal caudal peduncle (VCP-DCP)
Eye depth (ED)	Supraoccipital to Origin of Pectoral fin (SO – Opec)
Lower jaw length (LJL)	Dorsal caudal peduncle to Posterior Dorsal fin (DCP – PD)
Premaxilla – Supraoccipital (PM-Sup) (posterior margin)	Posterior anal fin to ventral caudal peduncle (PA-VCP)
Lower jaw – pectoral fin origin (LJ-Pec)	
Preopercular groove to posterior orbit (Preo – PO)	
Caudal fin length (upper lobe) (CFLU)	

**Fish material.** The following fishes were collected and used in morphological and genetic analyses. *Labeobarbus aeneus*: SAIAB 74205 (#55, 24.3 – 310.0 mm SL), SAIAB 74221 (#73, 18.3 – 430.0 mm SL), SAIAB 74229 (#62, 24.3 – 345.0 mm SL). *Labeobarbus kimberleyensis*: SAIAB 74206 (#32, 49.5 – 180.0 mm SL), SAIAB 74220 (#10, 90.0 – 510.0 mm SL), SAIAB 74230 (#12, 162.0 – 540.0 mm SL). Details of fish samples are given in the Appendix (Table I).

### 3.1.3 Results

**Abundance and habitat preferences.** Large adults of both species of yellowfish were collected in the main river channels using gill nets and angling. No habitat preferences were noted using these collection methods. Using 5m seine nets in both upper and lower Orange sites juveniles (10-20 cm TL) of *L. kimberleyensis* were collected in low- or non-flowing areas close to the main channel. At the Aliwal North collection site (see center and right foreground area of Fig. 3) a quiet area sheltered from the main channel by rocks produced the majority of the 32 *L. kimberleyensis*. Typically at this site one or two *L. kimberleyensis* would be caught on the first seine haul and after this no further specimens were caught. This process was repeated every few hours. Off-channel areas in the lower Orange during 2006 have produced similar results (Fig. 8 and Table 3). In contrast, *L. aeneus* showed no particular habitat

preferences. Night time seine hauls in these shallow areas indicated that juveniles of both yellowfish species tend to move into deeper waters at night. *Labeobarbus aeneus* were in all instances more abundant than *L. kimberleyensis* by a ratio of about 20-30:1.



**Figure 8.** The lower Orange River at Daberas Mine (28° 16' 17" S 16° 45' 39" E) showing low flow areas where juveniles of *L. kimberleyensis* were typically collected.

**Table 3.** Day and night time 5m seine net hauls at the Daberas mine site (lower Orange River, November 2006). P = present in additional hauls.

Species	Day seines (n=5)				Night seines (n=5)			
	Total	mean	SD	P	Total	mean	SD	P
<i>B. hospes</i>	0	0	0.00	+	69	13.8	10.64	+
<i>B. paludinosus</i>	1	0.2	0.45	+	2	0.4	0.55	+
<i>B. trimaculatus</i>	0	0	0.00	-	1	0.2	0.45	+
<i>L. capensis</i>	35	7	5.10	+	0	0	0.00	-
<i>L. aeneus</i>	41	8.2	3.90	+	28	5.6	3.05	+
<i>L. kimberleyensis</i>	2	0.4	0.89	+	0	0	0.00	-
<i>M. brevipinnis</i>	1	0.2	0.45	+	0	0	0.00	-
<i>O. mossambicus</i>	3	0.6	0.89	+	0	0	0.00	-
<i>Mugil cephalus</i>	0	0	0.00	+	0	0	0.00	-
Total # per haul	83	16.6	9.50		100	20	12.47	

**Species differences and inter-population variation and hybridisation.** Specimens of each species from the two collection areas are shown in Figure 9. Figure 10 shows a plot of the PCA loadings for Factors 1 and 2 with all variables for *L. aeneus* at both sites. This shows how much each feature contributes to a factor score. Generally all loadings greater than +0.5 and –0.5 contribute significantly to a factor score. The appendix (Figures I-V) show scatterplots of Principal Component Analysis (PCA) factors. Appendix Figure VI shows an ANOVA plot for PCA factor 2 for all yellowfish populations.

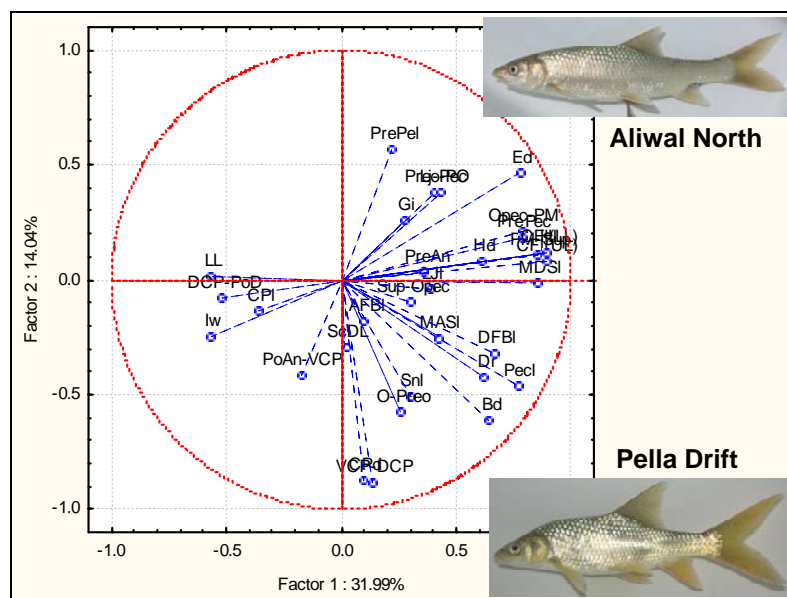
During the field collections all fish collected were clearly identifiable as one or the other species. Laboratory analysis of yellowfish morphology confirmed that individual specimens were consistently assigned to correct species groups (Figures IV-VI). Interestingly, the PCA factor plots for each species showed differing results.

*Labeobarbus kimberleyensis* specimens from both sites were not significantly different from each other in their overall morphology showing overlap in the PCA plots (Figures II, III & VI). This overlap is despite the samples being quite different in size (Table 5). If we had been able to collect specimens of the same size at each site a greater degree of overlap would be expected as several features were clearly shown to be allometric (altering with increasing body size). In contrast, *Labeobarbus aeneus* from the two sites were noticeably different in their morphology and colouration. PCA plots supported the field observations with no overlapping individuals in the plots despite specimens from the different sites being of similar size ranges and mean sizes (Figures I & VI).





**Figure 9.** *Labeobarbus* specimens collected. 1 - *L. aeneus* from Aliwal North (SAIAB 74205), 2 - *L. aeneus* from Pella Drift (SAIAB 74221), 3 - *L. kimberleyensis* from Aliwal North (SAIAB 74206), and 4 - *L. kimberleyensis* from Pella Drift (SAIAB 74220).



**Figure 10.** Projection of the loading on Factor 1 and Factor 2 from the PCA with all variables *L. aeneus* at both sites.

**Table 5.** Ranges and mean size of the fish samples used in the morphological study.

Species	Site	Size range (mm SL)	n	Mean
<i>L. aeneus</i>	Aliwal North	76.4 – 291.0	34	151.4
<i>L. aeneus</i>	Lower Orange	90.6 – 389.6	32	151.2
<i>L. kimberleyensis</i>	Aliwal North	50.3 – 176.9	32	123.9
<i>L. kimberleyensis</i>	Lower Orange	91.9 – 525.0	22	247.2

**Distinctive measurements.** Interorbital width (Appendix Figure VII) – *L. aeneus* from both sites had greater interorbital widths compared to *L. kimberleyensis*. This is probably due to *L. aeneus* having eyes more laterally positioned for foraging in the substrate compared to *L. kimberleyensis* which is more piscivorous catching its prey directly ahead of itself.

Body depth (Appendix Figure VIII) – *L. aeneus* from the lower Orange had significantly deeper bodies than *L. aeneus* from Aliwal and *L. kimberleyensis* specimens from both sites.

Posterior orbit to preopercular groove distance (PO-PG) (Appendix Figure IX) – this feature is one of the key characteristics used to distinguish between *L. aeneus* and *L. kimberleyensis* in Skelton's (2001) identification key. The PO-PG distance is greater in *L. kimberleyensis* than *L. aeneus* certainly associated with the overall elongation of the head in the more predatory *L. kimberleyensis*. There is a considerable difference in the PO-PG between *L. kimberleyensis* specimens from the two sites and this is certainly associated with the differing sizes of the two samples. The PO-PG distance increases with increasing SL. It is probable that small juvenile yellowfishes will not be distinguishable from each other using this feature.

Lower jaw length (Appendix Figure X) – *L. kimberleyensis* specimens have on average longer lower jaws compared to *L. aeneus*. This is presumably associated with increased gape size and the larger size of prey.

Fin sizes were larger in the lower Orange *L. aeneus* samples than any of the other yellowfishes samples. Interestingly, maximum dorsal fin spine length (Appendix Figure XI), dorsal fin base length (Figure XII) and pectoral fin length (Figure XIII) all show the same trend as with body depth.

### 3.1.4 Discussion and recommendations

There were consistent morphological differences between the two species from Aliwal North and the lower Orange. Although these two species are closely related these morphological differences presumably result from use of slightly different habitats and resources within the river. Thus *L. kimberleyensis* and *L. aeneus* are morphologically distinct and identifiable using several features e.g. mouth position, mouth size, eye to preopercular groove distance, colouration, interorbital width.

Certain features, however, exhibit allometry i.e. vary in their proportions with increasing body size. Eyes are negatively allometric, decreasing in size relative to body size as body size increases. Changing eye size affects several morphological measures used in this study such as snout length, interorbital width, orbit to preopercular groove distance and other features not used. Whilst this is the case with both yellowfish species it particularly impacts upon the eye to preopercular groove distance in *L. kimberleyensis* juveniles. Thus at smaller sizes this feature is not effective in distinguishing between the two species. Despite this feature being the key character used in Skelton's 2001 identification key we had no difficulty in identifying juveniles of the two species in the field using colouration, mouth position and mouth size.

Interestingly and unexpectedly the two species differed in their morphological variation between the two regions.

*Labeobarbus kimberleyensis* specimens were morphologically similar in the upper and lower Orange sites. This presumably indicates similar behaviour patterns and the use of similar habitats.

In contrast the two *L. aeneus* populations were morphologically different from one another. The most obvious differences were that the lower Orange *L. aeneus* had significantly deeper bodies and longer fins. The lower Orange River, as well as being a much bigger river than the upper reaches at Aliwal North, provides a much wider variety of habitats. The lower Orange is frequently braided into numerous channels, it has complex rocky habitats, shingle through to fine silt beds, submerged and emergent aquatic vegetation beds and has deeper channels and pools. Presumably, lower Orange *L. aeneus* are utilising slightly different habitats and resources here compared to those in the upper Orange River. From a management point of view it would be worth getting a better understanding of the use of habitats by *Labeobarbus*. In particular radio telemetry projects looking at habitat use of lower and upper Orange *L. aeneus* may give some insights into why there are morphological differences.

The existence of morphological variation between the two regions raises further questions to which as yet we don't have answers. Is there a genetic basis for this morphological variation? Is this variation a gradual cline down the river system or is there some discontinuity in the river system e.g. the Augrabies Falls? To answer these questions would require more intensive sampling within the river system which may be beyond the scope of this project. However, until this variation is understood the movement of yellowfishes within the Orange system should not be allowed. This situation could possibly be



exploited by FOSAF and other angling organisations by recognising lower and upper Orange *L. aeneus* as slightly different.

During the course of our collections for this project and later collections in 2006 it became obvious to us that *L. kimberleyensis* was significantly less abundant than *L. aeneus*. The levels of fishing may be an important impact upon larger specimens of both species. Although we did not observe gill netting numerous anglers complained to me about the extensive use of gill nets in the lower Orange. In the Vaal and upper Orange the numbers of people angling is also very high in certain localities. *Labeobarbus kimberleyensis* would probably benefit from enforcing the non-use of gill nets, protected areas where no fishing of any form occurs (these should include suitable spawning beds and nursery habitats) and encouraging all anglers to return all *L. kimberleyensis* caught alive.

### **3.1.5 References**

Skelton, P. 2001. *Freshwater Fishes of Southern Africa*. Struik Publishers, Cape Town.

## 3.1.6 Appendix

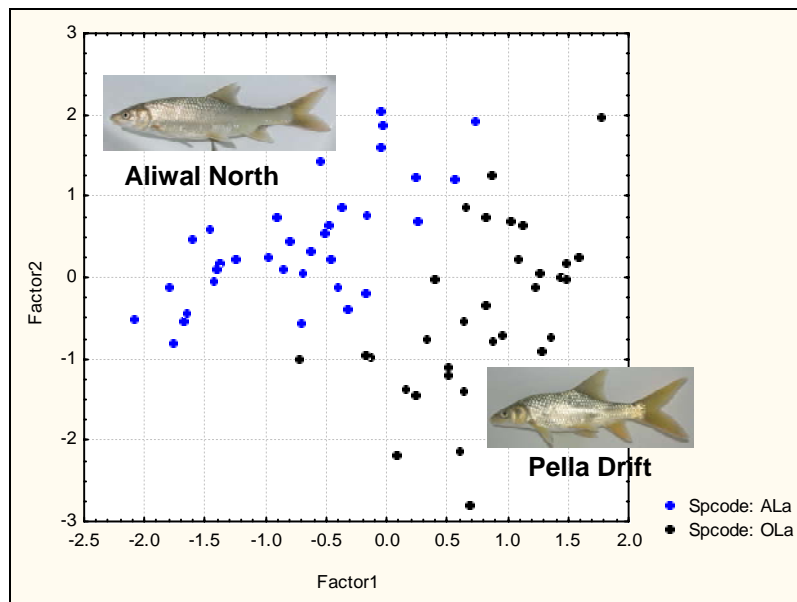
**Table I.** Details of *Labeobarbus* collections made at Aliwal North and the lower Orange River during January 2004.

Yellowfish samples collected 21/01/2004 to 30/01/2004						
Aliwal North (30° 40' 45" S 26° 43' 11" E)						
Site: wier above N6 road bridge - 30° 40' 45" S 26° 43' 11" E (one site successfully sampled)						
Site photos: 9979-9982						
Additional photos: juvenile <i>L. kimberleyensis</i> in bottle 1 - larger 9992-96, smaller 9997-0001						
Collection methods: S = 3m seine, H&L = hook and line (maize soaked in aniseed/almond), E = electrofishing, Gill net = G						
<i>Labeobarbus aeneus</i>						
Code	Date	Collection	DNA tissue samples	DNA #	Photos	TL (cm)
	(2004)	method	(cuts/id features)			
A-La-01	21/01/	S	small, left back, bottle 1	-	-	10.5
A-La-02	21/01/	S	medium, left, bottle 1	-	-	14.5
A-La-03	21/01/	S	Large, left, bottle 1	-	-	21.5
A-La-04	21/01/	S	small-med, right, bottle 1	-	-	11
A-La-05	21/01/	S	small, middle left, bottle 1	-	-	10
A-La-06	21/01/	S	small, both sides, bottle 1	-	-	10
A-La-07	22/01/	S	Large, left, bag 1	-	9986-88	29.5
A-La-08	22/01/	S	Large (smaller than 07), right, bag 1	-	-	24
A-La-09	22/01/	S	Large, middle left, bag 1	-	-	21.5
A-La-10	22/01/	S	medium-small, right, bag 1	-	-	17.5
A-La-11	22/01/	S	Small, left, bag 1	-	-	15.5
A-La-12	22/01/	S	Labels tied to each fish	-	-	24.2
A-La-13	22/01/	S	"	-	-	22.5
A-La-14	22/01/	S	"	-	-	22.5
A-La-15	22/01/	S	"	-	-	22
A-La-16	22/01/	S	"	-	-	?
A-La-17	22/01/	S	"	-	-	20.5
A-La-18	22/01/	S	"	-	-	16
A-La-19	22/01/	S	"	-	-	13.5
A-La-20	22/01/	S	"	-	-	16
A-La-21	22/01/	S	"	-	-	13
A-La-22	22/01/	S	"	-	-	15.5
A-La-23	22/01/	S	"	-	-	23.5
A-La-24	22/01/	S	"	-	-	36.5
A-La-25	22/01/	S	"	-	-	27.5
A-La-26	22/01/	S	"	-	-	23.5

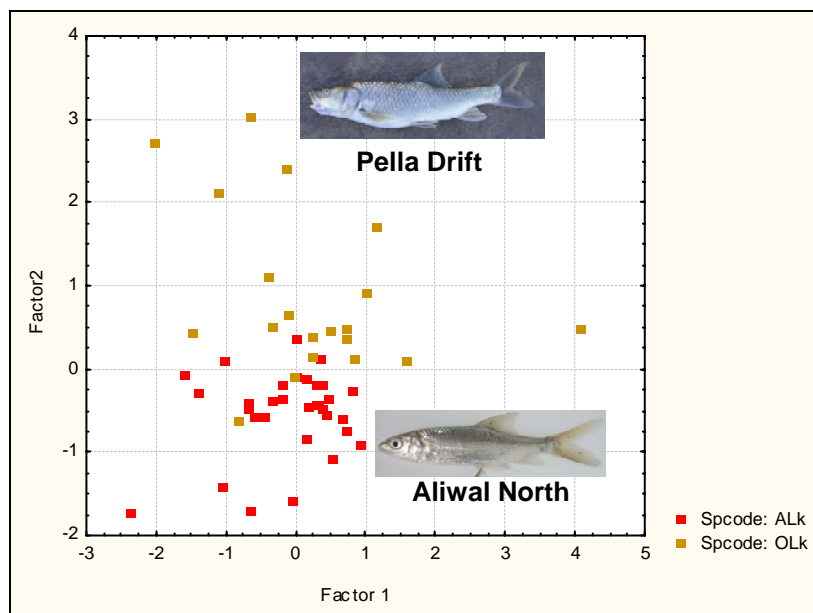
A-La-27	22/01/	S	"	-	-	21.5
A-La-28	22/01/	S	"	-	-	22.5
A-La-29	22/01/	S	"	-	-	21.5
A-La-30	22/01/	S	"	-	-	21
A-La-31	22/01/	S	"	-	-	20.5
A-La-32	22/01/	S	"	-	-	18
A-La-33	22/01/	S	"	-	-	18
A-La-34	23/01/	S	"	-	-	27
<b><i>Labeobarbus kimberleyensis</i></b>						
Code	Date	Collection	DNA tissue samples	DNA #	Photos	TL (cm)
		method	(cuts/id features)			
A-Lk-01	21/01/	S	Small, left, bottle 1	-	-	9.5
A-Lk-02	21/01/	S	Small, right, bottle 1	-	-	9
A-Lk-03	21/01/	S	medium, left, bottle 1	-	-	15.5
A-Lk-04	21/01/	S	Large, left, bottle 1	-	-	22.5
A-Lk-05	22/01/	S	Small, left, bag 1	-	9989-91	16.5
A-Lk-06	22/01/	S	Large, right, bag 1	Y78& Y83	-	18.5
A-Lk-07	22/01/	S	Labels tied to each fish	Y81	-	18.5
A-Lk-08	22/01/	S	"	-	-	17.5
A-Lk-09	22/01/	S	"	-	-	19.5
A-Lk-10	22/01/	S	"	-	-	17.5
A-Lk-11	22/01/	S	"	-	-	19.5
A-Lk-12	22/01/	S	"	-	-	16.5
A-Lk-13	23/01/	S	"	-	-	21
A-Lk-14	23/01/	S	"	Y79	-	16
A-Lk-15	23/01/	S	"	Y56	-	15
A-Lk-16	23/01/	S	"	Y53	-	16
A-Lk-17	23/01/	S	"	Y88	-	16.5
A-Lk-18	23/01/	S	"		-	23
A-Lk-19	23/01/	S	"	-	-	15
A-Lk-20	23/01/	S	"	-	-	20.5
A-Lk-21	23/01/	S	"	Y84	-	14.5
A-Lk-22	23/01/	S	"	Y69	-	15
A-Lk-23	23/01/	S	"	Y35	-	21
A-Lk-24	23/01/	S	"	Y38	-	21
A-Lk-25	23/01/	S	"	Y27	-	19.5
A-Lk-26	23/01/	S	"	-	-	19.5
A-Lk-27	23/01/	S	"	Y59	-	15.5
A-Lk-28	24/01/	S	"	-	-	18
A-Lk-29	24/01/	S	"	-	-	14
A-Lk-30	24/01/	S	"	-	-	10
A-Lk-31	24/01/	S	"	-	-	8
A-Lk-32	24/01/	S	"	-	-	7

<b>Lower Orange</b>						
Sites: farm at Onseepkans (28° 44' 31" S 19° 20' 07" E), Pella Drift upper (28° 57' 39" S 19° 09' 50" E) and lower (28° 57' 47" S 19° 08' 36" E)						
<i>Labeobarbus aeneus</i>						
Code	Date	Collection method	DNA tissue samples (cuts/id features)	DNA #	Photos	TL (cm)
<b>Onseepkans (28° 44' 31" S 19° 20' 07" E)</b>						
O-La-01	25/01/	S & E	Labels tied to each fish	-	-	19
O-La-02	25/01/	S & E	"	-	-	23.5
O-La-03	25/01/	S & E	"	-	-	12.5
O-La-04	25/01/	S & E	"	-	-	13
O-La-05	25/01/	S & E	"	-	-	13
O-La-06	25/01/	S & E	"	-	-	19.5
O-La-07	25/01/	S & E	"	-	-	13
O-La-08	25/01/	S & E	"	-	-	13.5
O-La-09	25/01/	S & E	"	-	-	12
O-La-10	25/01/	S & E	"	-	-	13.5
O-La-11	25/01/	S & E	"	-	-	13
<b>Pella Drift top site (28° 57' 39" S 19° 09' 50" E)</b>						
O-La-12	26/01/	S	"	-	-	15
O-La-13	26/01/	S	"	-	-	13
O-La-14	26/01/	S	"	-	-	13
O-La-15	26/01/	H&L	"	-	-	19.5
O-La-16	26/01/	H&L	"	-	-	27
O-La-17	26/01/	H&L	"	-	-	21.5
O-La-18	26/01/	H&L	"	-	-	22
O-La-19	26/01/	H&L	"	-	-	21.5
O-La-20	26/01/	H&L	"	-	-	22.5
O-La-21	26/01/	H&L	"	-	-	20.5
O-La-22	26/01/	H&L	"	-	-	21.5
O-La-23	26/01/	H&L	"	-	-	23
O-La-24	26/01/	H&L	"	-	-	18
O-La-25	26/01/	H&L	"	-	-	19.5
O-La-26	26/01/	H&L	"	-	-	17.5
O-La-27	26/01/	H&L	"	-	-	16.5
O-La-28	26/01/	H&L	"	-	-	16.5
O-La-29	27/01/	G	"	-	-	50
O-La-30	27/01/	G	"	-	-	34.5
<b>Pella Drift bottom site (28° 57' 47" S 19° 08' 36" E)</b>						
O-La-31	28/01/	G	"	-	-	42
O-La-32	28/01/	G	"	-	-	23.5
O-La-33	29/01/	H&L	"	-	-	22.5

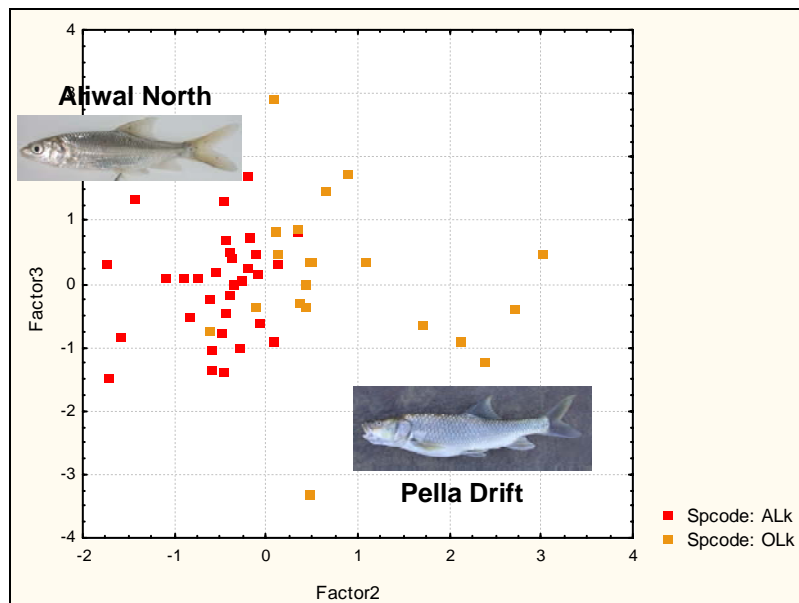
<i>Labeobarbus kimberleyensis</i>						
Code	Date	Collection	DNA tissue samples	DNA #	Photos	TL (cm)
		method	(cuts/id features)			
<b>Pella Drift top site (28° 57' 39" S 19° 09' 50" E)</b>						
O-Lk-01	27/01/	G	Labels tied to each fish	-	-	60
O-Lk-02	27/01/	G	"	-	-	39
O-Lk-03	27/01/	G	"	-	-	25
O-Lk-04	27/01/	H&L	"	-	-	12.5
O-Lk-05	27/01/	H&L	"	-	-	34.5
O-Lk-06	28/01/	G	"	-	-	23.5
O-Lk-07	28/01/	G	"	-	-	?
O-Lk-08	28/01/	G	"	-	0081-84	46
O-Lk-09	28/01/	G	"	-	-	32
O-Lk-10	28/01/	G	"	-	-	25.5
<b>Pella Drift - lower site (28° 57' 47" S 19° 08' 36" E)</b>						
O-Lk-11	28/01/	G	"	-	-	23.5
O-Lk-12	28/01/	G	"	-	-	27
O-Lk-13	28/01/	G	"	-	-	23.5
O-Lk-14	28/01/	G	"	-	-	21.5
O-Lk-15	29/01/	G	"	-	0129-136	65
O-Lk-16	29/01/	G	"	-	-	25
O-Lk-17	29/01/	G	"	Y64, Y41	-	51.5
O-Lk-18	29/01/	G	"	-	-	29
O-Lk-19	29/01/	H&L	"	-	-	48.5
O-Lk-20	29/01/	G	"	-	-	23
O-Lk-21	29/01/	G	"	-	-	27
O-Lk-22	29/01/	G	"	-	-	23.5



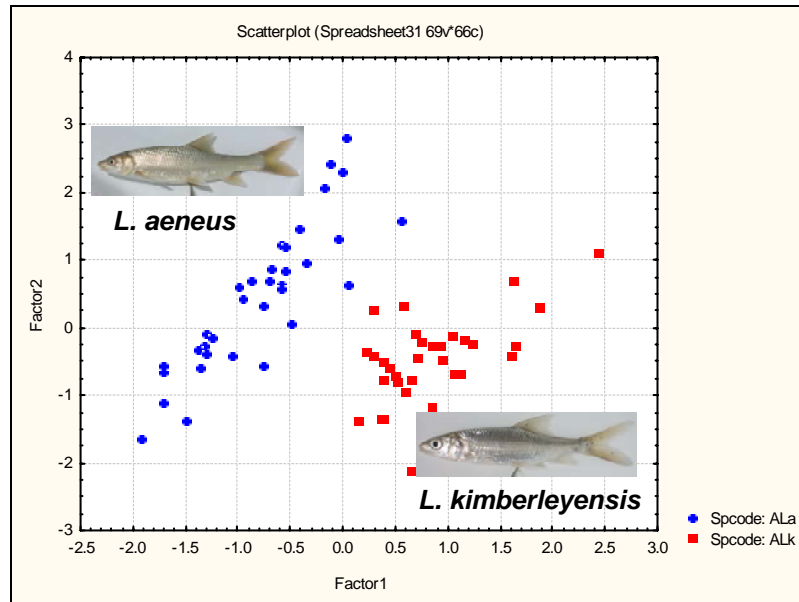
**Figure I.** A scatterplot for PCA factors 1 and 2 for *L. aeneus* populations from Aliwal North and the Lower Orange (Onseepkans to Pella Drift).



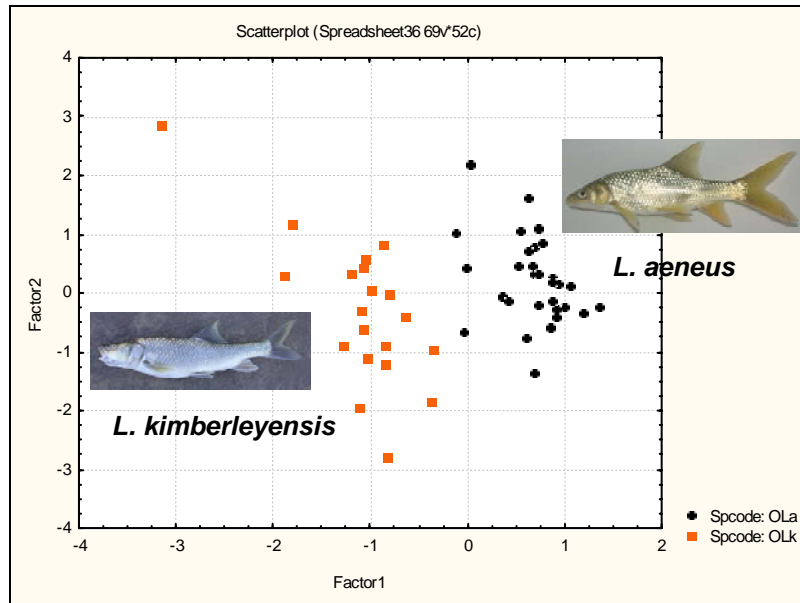
**Figure II.** A scatterplot for PCA factors 1 and 2 for *L. kimberleyensis* populations from Aliwal North and the Lower Orange (Onseepkans to Pella Drift).



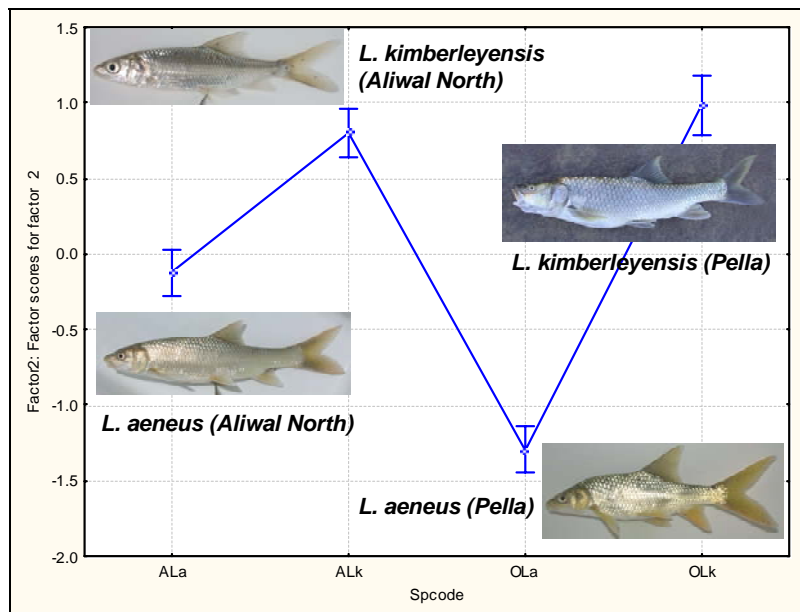
**Figure III.** A scatterplot for PCA factors 2 and 3 for *L. kimberleyensis* populations from Aliwal North and the Lower Orange (Onseepkans to Pella Drift).



**Figure IV.** A scatterplot for PCA factors 1 and 2 for *L. kimberleyensis* and *L. aeneus* from Aliwal North.

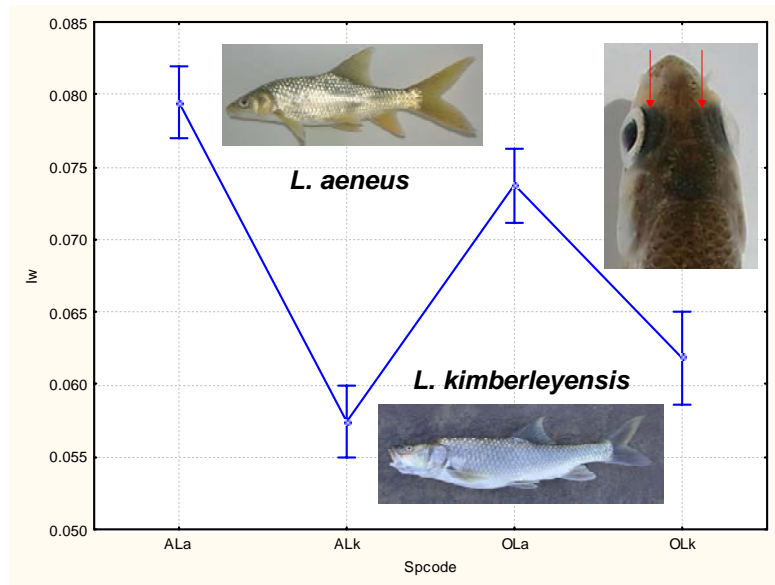


**Figure V.** A scatterplot for PCA factors 1 and 2 for *L. kimberleyensis* and *L. aeneus* in the Lower Orange (Onseepkans to Pella Drift).

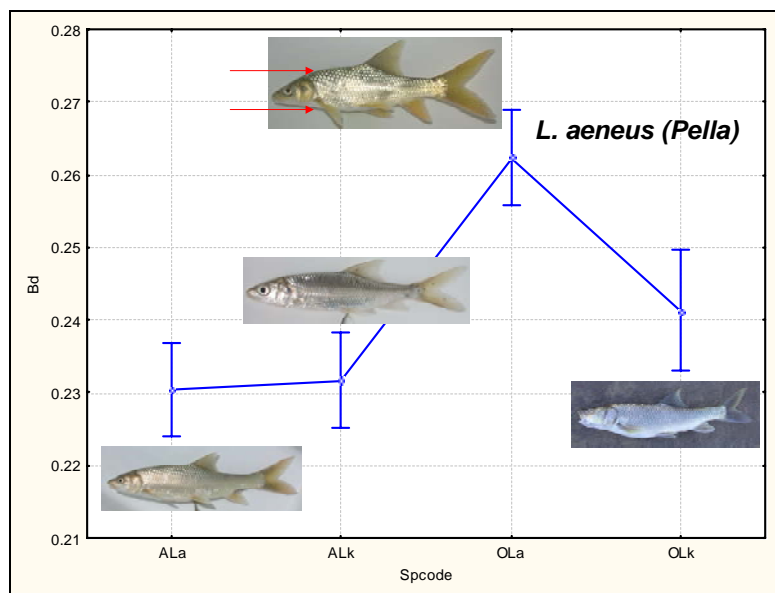


**Figure VI.** ANOVA of the PCA Factor 2 scores for all specimens.

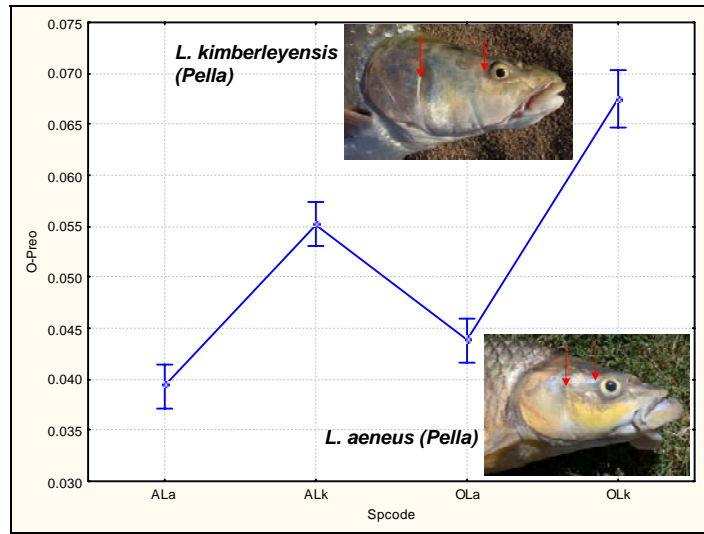




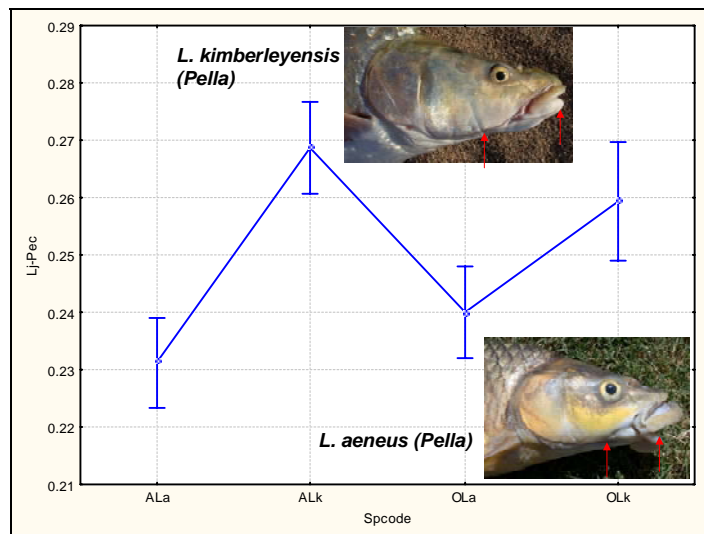
**Figure VII.** An ANOVA plot for interorbital width (IOW) versus standard length (SL) for *L. kimberleyensis* and *L. aeneus* from Aliwal and Lower Orange sites.



**Figure VIII.** An ANOVA plot for body depth (BD) versus standard length (SL) for *L. kimberleyensis* and *L. aeneus* from Aliwal and Lower Orange sites.



**Figure IX.** ANOVA of the distance between the posterior orbit and the preopercular groove/Standard length.



**Figure X.** ANOVA of lower jaw length/Standard length

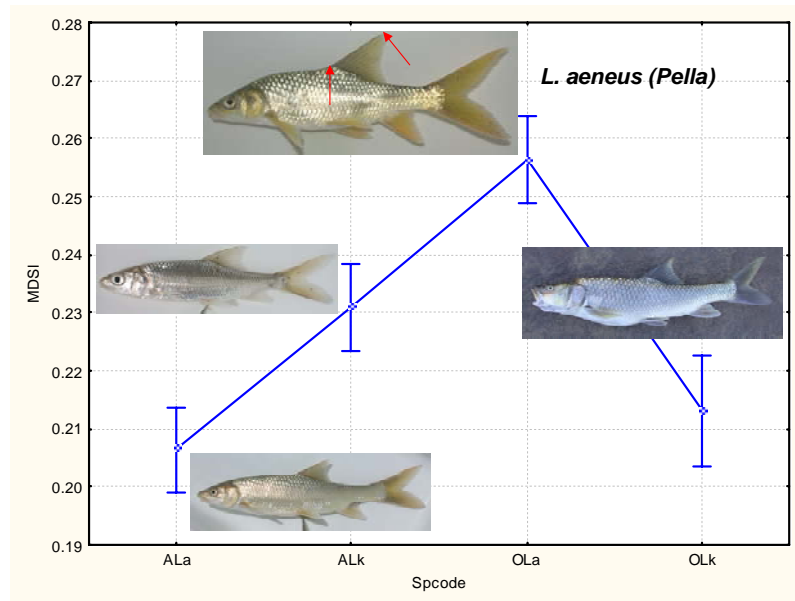


Figure XI. ANOVA of the maximum dorsal spine length / standard length.

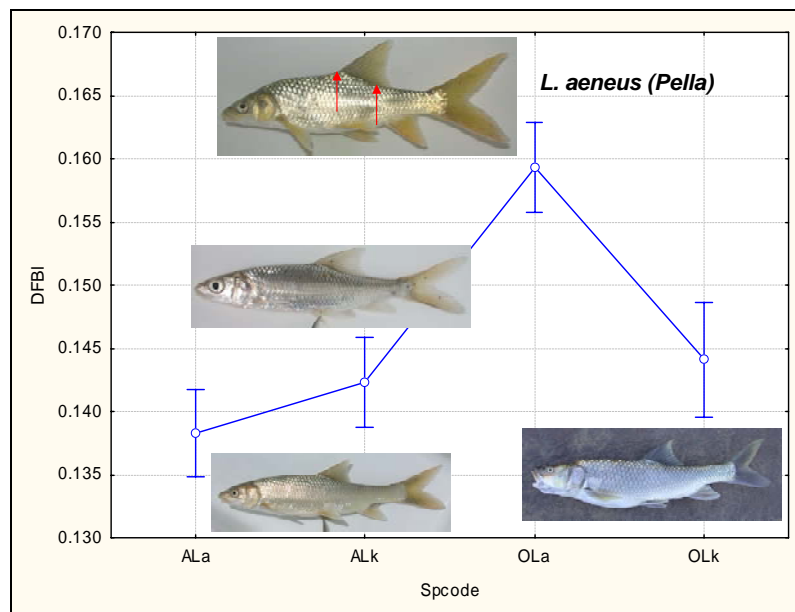


Figure XII. ANOVA of the dorsal fin base length / standard length.

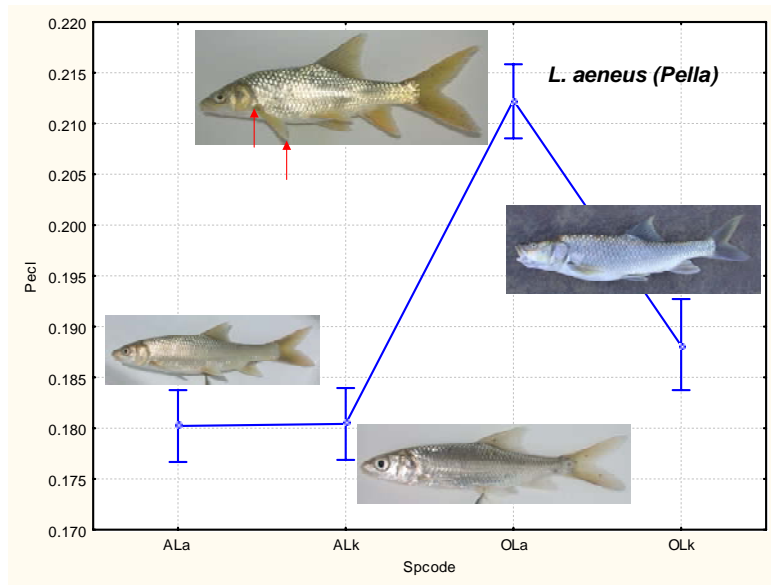


Figure XIII. ANOVA of pectoral length/standard length.

### 3.2 ALLOZYME STUDY OF *LABEOBARBUS AENEUS*, *L. KIMBERLEYENSIS* AND THEIR HYBRIDS

*Herman van der Bank & Gina Walsh*

*Department of Zoology, University of Johannesburg, P.O Box 524, APK, Auckland Park 2006, South Africa.*

#### 3.2.1 Abstract

Problems regarding the identification and genetic status of *Labeobarbus aeneus* and *L. kimberleyensis* are being experienced at present in natural populations in southern African river systems due to translocations. Both species have been actively promoted as angling species and this enhanced socio-economic status will no doubt be extremely valuable in their long-term preservation. Suitable conservation strategies need to assess the possibility of widespread hybridisation of these species within these systems. Allozyme analyses were done of *L. aeneus* and *L. kimberleyensis* samples from various systems, using *L. polylepis* from the Elands System, as an outgroup. It appears that genetically impure species occur at localities. No diagnostic genetic markers (i.e. that were reported previously by other researchers) were recorded in this study between the three *Labeobarbus* species. Since these data point to introgressive hybridisation, it is necessary to examine these yellowfish by combining traditional morphometrics with other parameters such as genetic, parasitological and mtDNA markers to confidently identify these fish. This will allow for the preservation of pure strains of the yellowfish in question and their ultimate survival through sustainable conservation tactics.

#### 3.2.2 Introduction

The large cyprinids of the genera *Labeobarbus* are valuable freshwater fish in Africa as they are a greatly sought after source of food for many rural people. Their importance extends to economical significance as they are highly regarded as an indigenous angling species in South Africa (Groenewald 1958). The identification of *L. aeneus* (Burchell 1822), *L. kimberleyensis* (Gilchrist & Thompson 1913) and *L. polylepis* (Boulenger 1907) has been traditionally based on distinguishing, classical morphological characteristics. In more recent years a number of unique protein markers have been described that allow identification and characterization of these yellowfish species on a genetic level (Mulder 1986, 1989).

*Labeobarbus aeneus* and *L. kimberleyensis* are endemic to the Vaal-Orange and other river systems, and it has been reported that over the years increasing problems have arisen with the utilization of traditional morphology as a means to distinguish between these species. The difficulty in distinguishing between these two yellowfish species has led to the speculation of hybridisation in numerous scientific papers (Gaigher 1976; Eccles 1986; Mulder 1986, 1989). Following these observations, Bloomer & Naran (2003) did a pilot study on *L. aeneus* and *L. kimberleyensis* based on mitochondrial DNA markers. The results indicate the possibility of recent divergence between the two species, or a more likely scenario of introgressive hybridisation.

From the above information it is necessary to make subsequent investigations into combining additional parameters in identification keys of these yellowfish species, such as allozyme studies, morphological variation and parasitological data. Allozyme studies are extremely informative and powerful tools as they have the ability to pin-point diagnostic loci, where fixed allele difference take place, as a means of genetic markers for a species. Because this method uses both maternal and paternal inheritance patterns, hybrids may be identified (Allendorf & Utter 1979).

What makes these circumstances even more important is the fact that in 1994 *L. kimberleyensis* was cited as being vulnerable on the International Union for Conservation of Nature and Natural Resources (IUCN) red list. According to the IUCN, a taxon is vulnerable when it is facing a high risk of extinction in the wild in the medium-term future (Groombridge 1994). In a press release entitled “river ethics and etiquette”, the Yellow Fish Working Group and Free State nature conservation have requested that any small or largemouth yellowfish that are caught in the Vaal River should be tagged and released, as there has been a decrease in numbers of both of these fish in recent years.

The objectives of this study served to determine the genetic status of *L. aeneus* and *L. kimberleyensis* species in relation to each other, using *L. polylepis* from the Elands System as an outgroup for genetic comparison. This study aimed to report variation and differentiation at the polymorphic loci identified by Mulder (1989), Mulder *et al.* (1990, 2004) and Van Vuuren *et al.* (1989) in muscle and liver samples for various populations. Detailed information on the methods is presented in the references cited. The results were compared with those obtained from morphological and DNA data sets by other researchers involved in the rest of the project. In addition, this study also sought to combine more traditional external morphometrical characteristics with biochemical genetic data to evaluate the reliability of these two approaches and to assess them as a means of identifying hybrids within populations with a view to eventually formulating a conservation strategy for these species. A research paper will be prepared and submitted for publication in an international or national journal.

### 3.2.3 Materials & Methods

**Allozyme study.** Fixed allozyme differences (100% different) for different species (e.g. only Esterase-1\*100 bands for *L. kimberleyensis* compared to only Esterase-1\*95 bands for *L. aeneus*; see Fig. 1) are a very useful diagnostic tool to identify species on a routine basis. Hybrids between the species will have both bands. This technique has the advantage that it is technically simple, very informative, the method allows for quick processing time, it is less expensive than other methods, and allozyme data constitute the largest existing genetic data set for many organisms (see Park & Moran (1995) for a comparison of various methods). The method is useful for defining genetic markers for stock identification (by documenting differences in protein allele frequencies between stocks), and differentiation (e.g. measured as genetic distance between taxa). It can also be used to estimate the effective number of individuals exchanged between generations (to determine the efficiency of gene flow between populations and taxa), and average heterozygosity (genetic variation to counter the effects of allele

fixation and differentiation between populations). It is, therefore, possible to establish if various individuals should be considered as part of a single, large genetic population, different species, hybrids, or not. Allozyme studies by Van Vuuren *et al.* (1989) identified diagnostic loci, with fixed allele differences for the above-mentioned species.

**Fish Stocks and Tissue Collection.** Yellowfish specimens were collected from different locations within their natural geographical distributions (Table 1). *Labeobarbus polylepis* were also collected from the Elands River in Mpumalanga to use it as an outgroup for genetic analysis. The fish from the Vaal and Elands rivers were collected with 90 mm gill nets in early March 2005 when the fish densities were still presumably high. These specimens were initially identified according to the position of their mouths and snout length in relation to preopercular length. The fish were then sacrificed by severing the spinal chord with scissors and a scalpel. Muscle, liver and heart tissue samples were collected on site and stored in cryotubes in liquid nitrogen in the field, whereafter the samples were transported to the laboratory and stored at -80°C.

**Sample preparation, Starch gel electrophoresis and Allozyme studies.** Muscle, heart or liver tissue from fish specimens were manually homogenized with a glass rod in distilled water (1:1 tissue to dH<sub>2</sub>O volume) and centrifuged at 3000 rpm for 3min. The supernatant was used in starch gel analysis by transferring the supernatant onto the gel with Whatman filter paper. Electrophoretic procedures, techniques and sample application are described in Van der Bank *et al.* (1992). Horizontal starch gel (12% hydrolyzed potato starch) electrophoresis was performed to detect heart and liver enzyme loci. The choice of buffer systems was pertinent in achieving maximum resolution in the gels. Three different buffer systems were used, namely a discontinuous RW gel (gel: pH 8.7, tray: pH 8), continuous TC gel (pH 6.9) and a continuous MF gel (pH 8.6; see Mulder (1986)). The gels were run at 40 mA until the dye marker had migrated sufficiently.

Table 2 indicates the protein coding loci that were screened for, based on markers from Mulder (1986) and Mulder *et al.* (2004). Enzymes are referred to as prescribed by the Nomenclature Committee of the International Union of Biochemistry and Molecular Biology (1992), and allelic nomenclature as prescribed by Van der Bank (2002). Multiple loci coding for functionally similar proteins were designated numerically from the cathodal end of the gel. Alleles at each locus were distinguished alphabetically by their mobilities relative to the mobility of the most common allele. Allozyme data was analysed using BIOSYS-2 (Swofford *et al.* 1981).

**Table 1.** The source and coordinates of the locations of *Labeobarbus* specimens used for allozyme analysis. Sample sizes are given for *L. aeneus* with those of *L. kimberleyensis* in brackets.

Species	Source	Locality	Sample size
<i>L. aeneus</i> & <i>L. kimberleyensis</i>	Vaal River – RAU Eiland	26°52'28.6"S 28°10'48.6" E	33 (15)
	Orange River – Aliwal North	30°40'45"S 26°43'11" E	34 (32)
	Lower Orange – Onseepkans	29°44'31"S 19°20'07" E	11 (10)
	Lower Orange – Pella Drift	28°57'39"S 19°09'50"E	33 (22)
	Sak River	31.7164 S 21.8483 E - 31.2544 S 22.1286 E	16
<i>L. polylepis</i>	Elands River – Ian's Place	25°36'48.5"S 30°30'25.5"E	16

**Table 2.** A summary of enzymes screened in *L. aeneus*, *L. kimberleyensis* and *L. polylepis* tissue samples. In the case of each protein that was screened for, the buffer systems are indicated upon which the samples were run.

Enzyme	Abbreviation	E.C No.	Buffer	Structure
Alcohol dehydrogenase	ADH	1.1.1.1	RW	Dimer
Adenylate kinase	AK	2.7.4.3	MF	Dimer
Esterases	EST	3.1.1.-	MF	Monomer
General protein	PROT	-.-.-.-	MF	Monomer
Lactate dehydrogenase	LDH	1.1.1.27	MF	Tetramer
Malate dehydrogenase	MDH	1.1.1.37	TC	Dimer
Mannose-6-phosphate isomerase	MPI	5.3.1.8	MF, TC	Monomer
Peptidase-S	PEP-S	3.4.-.-	TC, MF	Mono/Tetremer
Phosphoglucosmutase	PGM	5.4.2.2	TC	Monomer
Superoxide Dismutase	SOD	1.15.1.1	MF, RW	Dimer



### 3.2.4 Results & Discussion

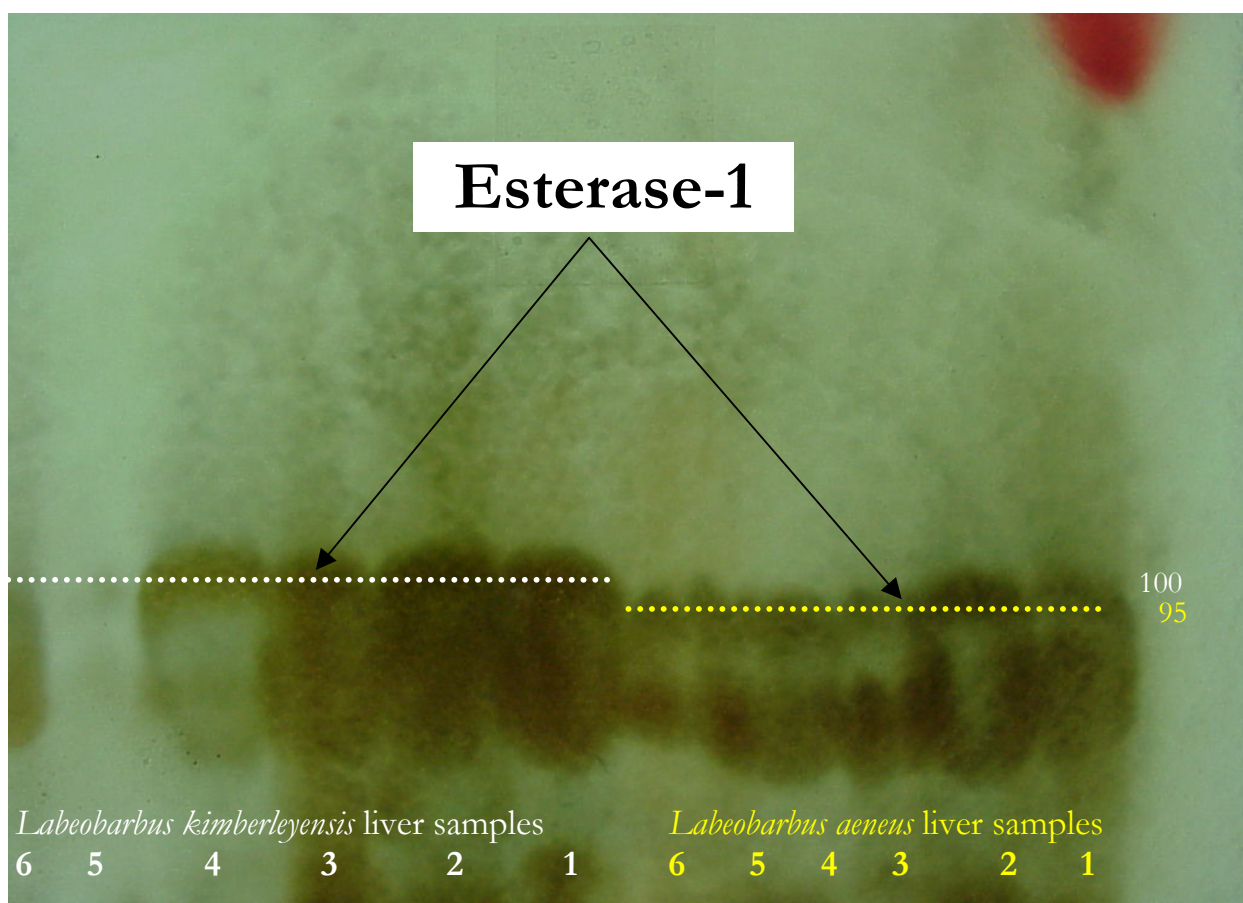
Mulder (1986) reported fixed allele differences between *L. aeneus* and *L. kimberleyensis* at SOD, but strangely not in his subsequent study (in 1989). He also obtained fixed allele differences between these species and *L. polylepis* at ADH-1, EST-1, -2, MDH-2, PGM-1, -2 and SOD-1 in 1989; at AK-1, LT-1 and -2 between *L. aeneus* and *L. kimberleyensis*; at MPI-1 between all three taxa, and at LT-1 and -2 between *L. kimberleyensis* and *L. polylepis*. Fixed allele differences were obtained at the Esterase-1 locus for the first six individuals each of *L. aeneus* and *L. kimberleyensis* (Fig. 1) at Onseepkans. Subsequent analyses of the rest of the population revealed allele frequencies of 0.750 and 0.952 for the Esterase-1\*100 allele and 0.250 and 0.048 at Esterase-1\*95 for these species respectively. All of the other individuals analysed had only the former allele. No fixed differences could be obtained for these species at any of the above loci in the present study, despite the duplication of the methods and using the same apparatus as Mulder (1986). However 17-20 years separate these studies, with conceivably as many generations in-between sampling. The differences in results can, therefore, be attributed to introgressive hybridisation. Although the allozyme analyses was useful in the past (e.g. for F<sub>1</sub> hybrids), it is not anymore due to backcrossing in the subsequent generations. This has probably happened because the hybrids are not sterile and can interbreed with any of the parent species. In the end some might look like pure species or hybrids based on morphology in the field, but the laboratory analyses showed that they now possess alleles from the other species. Conversely, it might also not be possible to verify the presence/absence of all the alleles with allozymes since the percentage of mixed genes might be too little to detect.

**Implications of introgressive hybridisation.** Introgressive hybridisation is defined as the exchange of genes between evolutionary lineages due to backcrossing, as opposed to dysgenesis hybridisation where inviable or infertile offspring are exclusively yielded (Seehausen 2004). Whether hybridisation is important as a mechanism that generates biological diversity is a matter of controversy. Some authors focus on hybridisation as a source of genetic variation, functional novelty and new species divergence, others argue against any important positive role because reduced fitness would typically render hybrids a dead end and generally results in convergence of species.

It appears that hybridisation between these species has taken place in the river systems studied. For example, Jubb (1967) recorded that *L. aeneus*, that was originally geographically restricted to the Vaal Orange System, was introduced into the Limpopo System. Thus the possibility of hybridisation between *L. aeneus* and *L. polylepis* is viable. In the Vaal system, the placement of the Vaal Barrage is an aspect that should be considered when taking into account the reasons for hybridisation between *L. aeneus* and *L. kimberleyensis*. Templeton (1981) suggested that circumstances that allow closely related species to cross breeding paths are normally due to ecological disruptions that cause “hybrid habitats”. This habitat then presents the ideal location for hybridisation and possible establishment of hybrids within this habitat because they may adapt more easily than the pure strains of fish to this environment. The positioning of the barrage would presumably slow the flow of water down in lower parts of the river considerably and create a hybrid habitat. *L. aeneus* are noted to prefer fast flowing, clear rivers and

generally does not do well in dams, as opposed to *L. kimberleyensis* which prefers slower flowing water and manages well in dams (Skelton 2001). The slowing down of water flow in these habitats due to the barrage would allow the formation of an intermediate habitat, which would allow the hybridisation and possible establishment of the intermediates noted in this study.

Seehausen (2004) states that “introgressive hybridisation can influence evolution in several ways by causing convergence of species, genetic swamping of one species by another, transfer of genetic material between species that may potentially facilitate their adaptive evolution providing mechanisms of divergence and the origin of new species.” The data collected in this study indicates that convergence of *L. aeneus* and *L. kimberleyensis* and the possibility of the loss of these species to a new hybrid species which would result in the ultimate loss of aquatic biodiversity. In many cases, most hybrid genotypes tend to be less fit than are the parental genotypes in parental habitats, owing either to endogenous or exogenous selection or both. However, theory predicts that some can be of equal or superior fitness in new habitats and, occasionally, even in parental habitats (Wright 1978). The problem arises here as to whether these yellowfish hybrids will develop competition between themselves and the pure groups that will lead to the demise of the pure strains within their own habitat.



**Figure 1.** Fixed allozyme differences for six individuals each (numbered above from right to left) of two species at the Esterase-1 enzyme coding locus.

### 3.2.5 Conclusions

The results of this study indicate introgressive hybridisation amongst these species and thus more parameters need to be combined in order to distinguish between pure and hybrid *Labeobarbus* species. In addition, a study should be undertaken on isolated populations of these species as a reference for further studies. Mulder (1986, 1989) described numerous genetic markers and morphometric characteristics that could be used to distinguish between *L. aeneus*, *L. kimberleyensis* and hybrids of these species. Approximately 17-20 generations down the line since the last study made it almost impossible to use these parameters as a means of positive identification because of overlapping and undifferentiated genetic data. This extensive hybridisation calls for more careful sampling, additional parasite data and more polymorphic markers to identify these endemic *Labeobarbus* species. A breeding program should be initialized to conserve pure strains of these species. The most recent study indicates that allozyme analyses are not accurate anymore to differentiate between the taxa, and other molecular techniques should be employed in order to address this problem. Further monitoring is needed to determine the extent to which the yellowfishes have spread in our rivers because freshwater fishes are the most threatened of all vertebrate groups exploited by humans.

### 3.2.6 References

- Allendorf, F.W. & Utter, F.M. 1979. Population Genetics. In: *Fish Physiology* (Hoar, W.S., Randall, D.J., & Brett, J.R. Eds.), Academic Press, New York. pp. 407-454.
- Bloomer, P. & Naran, D. 2003. Identification of conservation units of two yellowfish species: *Labeobarbus kimberleyensis* and *L. aeneus*. Progress Report (March 2003) to FOSAF.
- Boulenger, G.A.. 1907. *Zoology of Egypt. Fishes of the Nile*. Hugh Rees, London. pp. 170-173.
- Burchell, W.J. 1822. *Travels in the Interior of South Africa*. Longman, Hurst, Rees, Orme, Brown and Green, London.
- Eccles, D.H. 1986. Development of the gut in the South African cyprinid fish *Barbus aeneus* (Burchell). *S. Afr. J. Zool.* 21(2): 165-169.
- Gaigher, I.G. 1976. The reproduction of *Barbus cf. kimberleyensis* (Pisces, *Cyprinidae*) in Hardap Dam, South West Africa. *Zool. Afr.* 11(1): 97 – 110.
- Gilchrist, J.D.F & Thompson, W.W. 1913. The fresh-water fishes of South Africa. *Ann. S. Afr. Mus.* 11(5). pp. 321-464.
- Groenewald, A.A.V.J. 1958. A revision of the genera *Barbus* and *Varicorhinus* (Pisces: Cyprinidae) in *Transvaal. Ann. Trans. Mus.* 23(3) 263-330.
- Groombridge, B. 1994. *1994 IUCN Red List of Threatened Animals*. IUCN, Gland, Switzerland.
- Jubb, R.A. 1967. *Freshwater Fishes of southern Africa*. Gothic Printing Company, Cape Town, pp. 83 – 88.
- Mulder, P.F.S. 1986. 'n Vergelykende morfometriese en elektroforetiese ondersoek van *Barbus aeneus* en *Barbus kimberleyensis*. MSc dissertation. Johannesburg: Rand Afrikaans University.
- Mulder, P.F.S. 1989. The development of a genetic data bank for the economically important *Barbus* species in South Africa. PhD thesis. Johannesburg: Rand Afrikaans University.

- Mulder, P.F.S., Van Vuuren, N.G., Ferreira, J.T. & Van der Bank, F.H. 1990. A preliminary biochemical comparison of two species of the genus *Barbus* from the Vaal River system. *Water SA*. 16(3): 147 – 150.
- Mulder, P.F.S., Engelbrecht, D., Engelbrecht, J.S. & Roux, F. 2004. Biochemical genetic variation between four populations of *Labeobarbus polylepis* from three river systems in South Africa. *African Journal of Aquatic Science*. 29(1): 97 – 102.
- NC-IUBMB (Nomenclature Committee of the International Union of Biochemistry and Molecular Biocyclature). 1992. Enzyme Nomenclature, Academic Press, New York.
- Park, L.K. & Moran, P. 1995. Developments in molecular genetic techniques in fisheries. In: *Molecular Genetics in Fisheries* (Carvalho, G.R. & Pitcher, T.J., eds.), Chapman & Hall, London, pp. 1-9.
- Seehausen, O. 2004. Hybridisation and adaptive radiation. *Trends in Ecology and Evolution*, 19(4): 198-207.
- Skelton, P. 2001. *Freshwater Fishes of Southern Africa*. Struik Publishers, Cape Town. pp. 166-175.
- Swofford, D.L., Selander, R.B. & Black W.C. 1981. BIOSYS-2: A computer program for the analysis of allelic variation in genetics. Accessed and active on 20/06/2005 from <ftp://lamar.colostate.edu/pub/wcb4>
- Templeton, A.R. (1981). Mechanisms of speciation – a population genetic approach. *Annu. Rev. Ecol. Syst.* 12: 23–48.
- Van der Bank, F.H. 2002. A review of gene nomenclature for enzyme-coding loci generally used in allozyme studies. *Trends in Comparative Biochem. & Physiol.* 9: 197 – 203.
- Van der Bank, F.H., Grobler, J.P & Du Preez, H.H 1992. A comparative biochemical genetic study of populations of domesticated and wild African catfish (*Clarias gariepinus*). *Comp. Biochem. Physiology*. 101B: 387-390.
- Van Vuuren, N.G., Mulder, P.F.S., Ferreira, J.T. & Van der Bank, F.H. 1989. The identification of hybrids of *Barbus aeneus* X *Barbus kimberleyensis* and *Labeo capensis* X *Labeo umbratus* in Hardap Dam, SWA/Namibia. *Madoqua*, 16(1): 27-34.
- Wright, S. 1978. *Evolution and the Genetics of Populations. Vol 4. Variability within and among Natural Populations*. University of Chicago Press, Chicago.
- Yellowfish Conservation, River Ethics & Etiquette. accessed and active on 09/07/2005 from <http://www.stywelyne.co.za/yellowfish.htm>

### 3.3 Mitochondrial DNA variation of *Labeobarbus aeneus* and *L. kimberleyensis*

#### *Paulette Bloomer*

Molecular Ecology & Evolution Programme, Dept. of Genetics, University of Pretoria, Pretoria, 0002, South Africa.

#### 3.3.1 Abstract

A pilot study conducted in 2002-2003 reported a lack of mitochondrial DNA (mtDNA) differentiation between smallmouth and largemouth yellowfish from localities representative of the geographical distributions of the two species (Bloomer 2006). The pilot study recommended a multi-disciplinary follow-up study to attempt to resolve the alternative scenarios proposed by the initial analysis of mtDNA variation. Here I report on a follow-up mtDNA analysis of material collected from the Sak river (the type locality of *L. aeneus*), the upper Orange at Aliwal North and the lower Orange (below Augrabies falls). These samples were also analysed for morphological variation (see section 3.1) and allozyme differentiation (refer to section 3.2). The mtDNA variation among the new samples were interpreted within the framework of the variability characterised in the pilot study and also within the broader framework of mtDNA variation in the genus *Labeobarbus*. Twenty two unique maternal alleles were identified among 92 Orange-Vaal samples; some alleles are shared between many individuals and were recorded from several sites whereas other alleles occurred at low frequencies. In agreement with the pilot study, *L. aeneus* and *L. kimberleyensis* from the Sak River, upper Orange (Aliwal North) and lower Orange (Onseepkans and Pella Drift), shared some maternal alleles. This could be due to the presence of shared ancestral alleles dating to before the split between the two closely related species or could indicate introgressive hybridisation of *L. aeneus* alleles into *L. kimberleyensis*. Variation within Orange-Vaal yellowfish is much lower than that observed in *L. natalensis* (the KwaZulu-Natal scaly) based on a small pilot investigation of variation in the latter species. With the exception of mtDNA alleles in the lower Orange, the remainder of the lineages within *L. aeneus* and *L. kimberleyensis* indicate a recent rapid spread of a few alleles throughout the system. Some of the *L. aeneus* from the lower Orange have more genetically distinct alleles and this area should be investigated in greater depth and treated as a separate conservation unit.

#### 3.3.2 Introduction

*Labeobarbus kimberleyensis* (largemouth yellowfish) and *L. aeneus* (smallmouth yellowfish) are endemic to the Orange-Vaal river system of southern Africa. The species are co-distributed throughout most of their range, however, while *L. aeneus* commonly occurs in large numbers, *L. kimberleyensis* is considered as threatened and is more elusive. As part of the original pilot study (Bloomer 2006) we initially analysed 30 samples by determining the DNA sequence of a part of the mtDNA control region (624 DNA bases of sequence). Ten of the samples had an identical DNA sequence and, for the DNA region analysed, one would then conclude that they share the same maternal allele (this means that there may be slight differences between them elsewhere in the total mitochondrial sequence of about 16 000 base

pairs). What was unusual was that these 10 identical individuals included seven smallmouth and three largemouth yellowfish samples from quite widespread areas. Also, an additional 16 samples including both smallmouth and largemouth yellowfish had alleles very similar to this common allele (with only one to two DNA differences between them). Only four smallmouth yellowfish samples had DNA sequences (in other words, maternal alleles) that were very distinct and these could further be distinguished into two groups: (1) a sample from Blouputs in the lower Orange with seven differences relative to the common allele and one from the Orange River Mouth with nine differences relative to the common allele, and (2) one sample from the Kraai River (upper Orange) with eight differences and one from Blouputs with 10 differences. We developed a diagnostic test to screen the remainder of the samples as it was clear that most fish are genetically quite similar to each other and for the purposes of the pilot study it was not necessary to determine the full DNA sequence of each individual. As expected we found that most, 223 of the 265 samples, were genetically identical or similar to the common allele while the remainder linked with one of the two divergent groups.

What did these results suggest regarding diversity within the two species and the identification of populations that require separate management? (1) The overall level of diversity was lower than what we would expect if the ancestor of the two species has been in the system since at least 2-3 million years ago (Jubb 1964). We proposed that future research would have to determine whether this is due to (a) a shorter period of time in the system, (b) a reduction in population size in the past followed by a more recent population expansion, (c) high levels of gene flow throughout the whole system, or (d) a low mutation rate leading to few differences between alleles. (2) The two species could not be distinguished from each other solely on the basis of mtDNA variation as they shared a common allele. We proposed that future research would have to determine whether this is due to (a) a more recent separation of the two species than suggested by earlier authors and too few generations since the species' split for mtDNA alleles to become different, (b) historical or recent hybridisation between the two species, or (c) the two species merely representing two morphological and ecological variants of the same species. (3) There were unique lineages within smallmouth yellowfish, mostly in the lower Orange below Augrabies Falls and in the Kraai River. We proposed that as a precautionary principle these areas should be treated as separate conservation units until the issues raised in points (1) and (2) could be resolved (Bloomer 2006).

Here I report extending the pilot mtDNA study in two ways: (1) Individuals sampled from the Sak River and the Orange River at Aliwal North and Onseepkans/Pella, that were also analysed for morphological and allozyme variation, were screened along with a number of outgroups (samples of other smallscaled yellowfish species) for variation in the mtDNA control region and these new results were interpreted within the framework of the existing sequences from the pilot study and (2) representatives of all the species within the smallscaled group of yellowfishes were screened for variation in the protein coding cytochrome *b* gene for which we can tentatively date the rate of change in the gene over time and therefore also calculate an approximate date of separation between the species.

### 3.3.3 Materials and methods

**Materials.** Table 1 summarizes the material available and the sample sizes analysed to date. For detailed information of sampling at Aliwal North, Onseepkans and Pella Drift please refer to sections 3.1.6 and 3.2.3 above.

**Table 1.** The sources of *Labeobarbus* specimens used for mtDNA control region analysis (locality information of alleles identified in the pilot study is provided in the Appendix, Table 1).

Species	Source (Locality, collector=Roger Bills (RB) or Herman van der Bank (HvdB))	Sample size collected	Sample size analysed to date
<i>L. aeneus</i>	Vaal River – RAU Eiland (HvdB)	33	6
	Orange River – Aliwal North	34	10
	Lower Orange – Onseepkans	11	11
	Lower Orange – Pella Drift	22	20
	Sak River	16	11 (+4 of pilot study)
<i>L. kimberleyensis</i>	Vaal River – RAU Eiland	15	5
	Orange River – Aliwal North	32	14
	Lower Orange – Pella Drift	22	22
<i>L. polylepis</i>	Elands River – Ian’s Place (HvdB)	16	7
	SAIAB 70692 Usuthu system), 70708 (Nkomati system)	2	2
<i>L. natalensis</i>	KZN rivers (YWG sampling)	42+	19
<i>L. capensis</i>	SAIAB 78525, Rondegat River	1	1
TOTAL			128

A limited number of samples were used for comparison of cytochrome *b* sequences. The aim of this analysis was principally to evaluate relationships and the potential timeframe of differentiation between the closely related smallscaled yellowfish species within the context of previous analysis of mtDNA diversity in the genus and related cyprinid species (see Tsigenopoulos *et al.* 2002). Sequences generated in the present study and ones downloaded from GenBank are summarized in Table 2.

**Table 2.** The sources of *Labeobarbus* and outgroups used for mtDNA cytochrome *b* analysis and sequences of Tsigenopoulos *et al.* (2002)<sup>1</sup> and Tsigenopoulos *et al.* (unpublished data)<sup>2</sup> retrieved from GenBank.

Species	Locality	GenBank Accession Number
<i>L. aeneus</i>	GenBank: No locality provided Lower Orange, control region alleles A02, A21	AF180876 <sup>1</sup> Present study
<i>L. kimberleyensis</i>	Aliwal North and Lower Orange, allele A01, A02	Present study
<i>L. natalensis</i>	Tugela river	Present study
<i>L. polylepis</i>	Incomati River, South Africa	AF180877 <sup>1</sup>
<i>L. capensis</i>	Olifants River, South Africa	AF180831 <sup>1</sup>
<i>L. marequensis</i>	Tzaneen Lake, South Africa	AF180830 <sup>1</sup>
<i>L. johnstoni</i>	Karonga, Malawi SAIAB78388	Present study
<i>Varichorinus nelspruitensis</i>	GenBank: No locality provided	AF180866 <sup>1</sup>
<i>Capoeta</i>	GenBank: No locality provided	AF145950 <sup>2</sup>
<i>B. reinii</i>	Tensift River, Morocco	AF145946 <sup>2</sup>
<i>B. lutens</i>	Tigris River, Turkey	AF145944 <sup>2</sup>
<i>B. mattozi</i>	Zambezi, Mozambique	AF180838 <sup>1</sup>

**Methods.** Following international standards this study used mtDNA for the identification of variation within and between yellowfish species. There are several reasons why mtDNA is an ideal marker: It is maternally inherited and there is therefore no recombination between maternal and paternal alleles that can obscure ancestry patterns. It has a high mutation rate (especially in the control region which is an area that does not code for a particular protein) and a lower effective population size than nuclear genes. Consequently mtDNA has a treelike pattern of ancestry, and relatively high levels of variation but it is sensitive to changes in population size and/or connectivity (Avice 2000 and references therein, Knowles & Maddison 2002). Mitochondrial DNA has been used extensively in the study of variation within and among freshwater fish species (see for example Table 4.2 of Avice 2000). In South Africa mtDNA regions have been used for assessing genetic diversity within and among endemic freshwater fish species and populations of the Cape Fold Mountains (Waters & Cambrey 1997, Impson & Bloomer 1998/9, Bloomer & Impson 2000, Van Niekerk 2004, Roos 2004, Swartz 2005).

**DNA extraction, PCR and DNA sequencing.** Total genomic DNA was isolated from frozen tissue or fin clips using standard protocols of chemical digestion and phenol/chloroform extraction (Sambrook *et al.* 1989) or using Chelex resin following the protocol of Estoup *et al.* (1996). A short variable region of the control region was PCR amplified using *Labeobarbus* specific primers designed in



the pilot study. The entire cytochrome *b* was amplified using primers GluF and ThrR of Machordom and Doadrio (2001). PCR and cycle sequencing were performed in a Geneamp® PCR System 9700 (Applied Biosystems). PCR amplification was performed in 25 µl volumes, each containing 1 x buffer, 2.5 mM MgCl<sub>2</sub>, 0.2 mM of each of the four nucleotides (Promega), 12.5 pmol of each primer and 1.5 U of Super-Therm DNA polymerase (Southern Cross Biotechnology) and approximately 100 ng template DNA. PCR cycling conditions involved an initial denaturation of 5 min at 94°C, followed by 35 cycles of 30 seconds at 94°C, 30 seconds at 56°C and 51°C for cytochrome *b* and the control region respectively, and 30 seconds at 72°C, with a final extension of 7 min at 72°C. PCR products were precipitated using sodium acetate and EtOH, followed by elution in Sabax water (Adcock Ingram). Cycle sequencing was performed in 5 µl volumes with the reaction mix containing 100 ng of purified PCR template, 1.6 pmol of one of the above-mentioned primers and 1 µl of ABI PRISM Big Dye Terminator Cycle Sequencing Ready Reaction Kit (Applied Biosystems). Cycle sequencing and precipitation of the products followed the manufacturer's instructions. Nucleotide sequences were determined through electrophoresis on an ABI3100 automated sequencer. Consensus sequences were obtained from the forward and reverse sequences through alignment and inspection in Sequence Navigator 1.01 (Applied Biosystems). These sequences were aligned using Clustal X (Thompson *et al.* 1997) and checked manually. For later publication purposes the sequences of unique alleles will be deposited in GenBank.

**Analysis of DNA sequence variation.** First the newly generated sequences of individuals collected from the Sak River and the Orange River (N=92) were analysed independent of the pilot study data. Aligned sequences from Clustal X were analysed using statistical parsimony in TCS (Clement *et al.* 2000). This enabled an evaluation of the diversity within and between the two species and to identify unique alleles and their geographic distribution. DNASP version 4.0 (Rozas *et al.* 2003) was used to test for neutral evolution of the control region analysed in this study using Tajima's D test statistic (Tajima 1989) and to calculate diversity indices such as allelic (Nei 1987) and nucleotide diversity (Tajima 1983). Arlequin 2.0 (Schneider *et al.* 2000) was used to plot a mismatch distribution of pairwise differences between the Orange-Vaal samples. The observed distribution was compared to the expected distribution under a population growth and decline model (Harpending 1994, Rogers 1995). An Analysis of Molecular Variance (AMOVA, Excoffier *et al.* 1992) was also conducted in Arlequin 2.0. The analysis partitions the overall variation into two or three components such as: 'between pre-defined groups', 'among populations within these groups' and 'within populations'. The amount of variation within populations relative to the total variation gives an indication of population structure ( $F_{ST}$ , Wright 1951). The significance of the variance components were evaluated using 10 000 permutations.

**Phylogenetics analysis.** Unique control region alleles identified among the follow-up study samples were analysed independently and also with sequences generated in the pilot study as well as sequences of the related smallscaled species, *L. polylepis*, *L. natalensis* and *L. capensis*. Only *L. capensis* was specified as the outgroup for a distance based phylogenetic analysis of the sequences based on the neighbour-joining algorithm (Saitou and Nei 1987) and parsimony (Hennig 1966) as implemented in PAUP\*

(Swofford 2003). A limited number of cytochrome *b* sequences generated thus far were analysed with sequences retrieved from GenBank (Tsigenopoulos *et al.* 2002, Tsigenopoulos *et al.* unpublished data, refer to Table 2 above). Confidence in inferred relationships were determined based on 1000 bootstrap replicates (Felsenstein 1985).

### 3.3.4 Results and discussion

**Variation among 92 Orange-Vaal samples.** Twenty-two unique alleles were identified based on variation at 20 sites within a 320 base pair fragment of the 5' variable segment of the mtDNA control region (Table 1). Several of the alleles are shared (8 of the 22 alleles were found in more than one individual), with a number of high frequency alleles (such as allele A01 that was recorded from 39 individuals at all five sampling sites and in both species). Within our sample, a small number of alleles (14) were only recorded from single individuals.

A moderate level of allele diversity (0.596) and a relatively low level of nucleotide diversity (0.7%) were recorded. These summary statistics not only allow comparison across different freshwater fish species but can reveal information about the population/species history of the species under investigation. Allele diversity gives an indication of the number and frequencies of alleles irrespective of the actual sequence differences between them; when randomly drawing any two individuals from the population, it reflects the probability of the two individuals having different alleles. Allele diversity ranges from 0 to 1, with 0 indicating that all individuals are identical whereas a value of 1 would be obtained if each individual had a unique allele. The allele diversity estimated among the 92 samples analysed here thus indicates a reasonable degree of differentiation among individuals, although the value is much lower than found within other freshwater fish in South Africa, for example in redfins (*Pseudobarbus*), where lineages within single species are often isolated in different river systems, values higher than 0.8 are typically recorded (see for example Bloomer & Impson 2000, Swartz 2005).

Nucleotide diversity shows the extent of sequence difference among alleles. The estimate is influenced by the frequencies of different alleles but not by the number of different alleles. On average, the alleles in the present study differed from each other at 2 sites within the 320 bp region (<1%); this is quite low. The number of pairwise differences however ranged from 0-10. Based on sequence differences, allele A01-A09, A10-A13 and A14-A22 were similar to each other respectively. Several alleles were recorded from both species (A01-A03) and many alleles unique to one of the two species were closely linked to one of these alleles. Alleles A14-A22 which differed by 4-10 differences from the remainder of the alleles were only recorded among *L. aeneus* from the lower Orange. These results correspond to observations made in the pilot study (see section 3.3.2 and Bloomer 2006). Although fewer individuals identified as *L. kimberleyensis* in the field were analysed (N=36), this group showed less variation in terms of number of alleles (six alleles) and diversity among alleles, compared with individuals identified as *L. aeneus* (19 alleles among 56 individuals).

**Table 1.** Unique mtDNA control region alleles identified among 92 Orange-Vaal yellowfish. The unique sequence for each allele is given with reference to the most common allele, allele A01. Dots indicate variable positions in the control region sequence where a particular allele has the same base as the reference allele; differences at particular positions are indicated by showing the altered bases (G, A, T or C) relative to the base in the reference sequence. ‘N’ indicates the number of individuals with a particular allele.

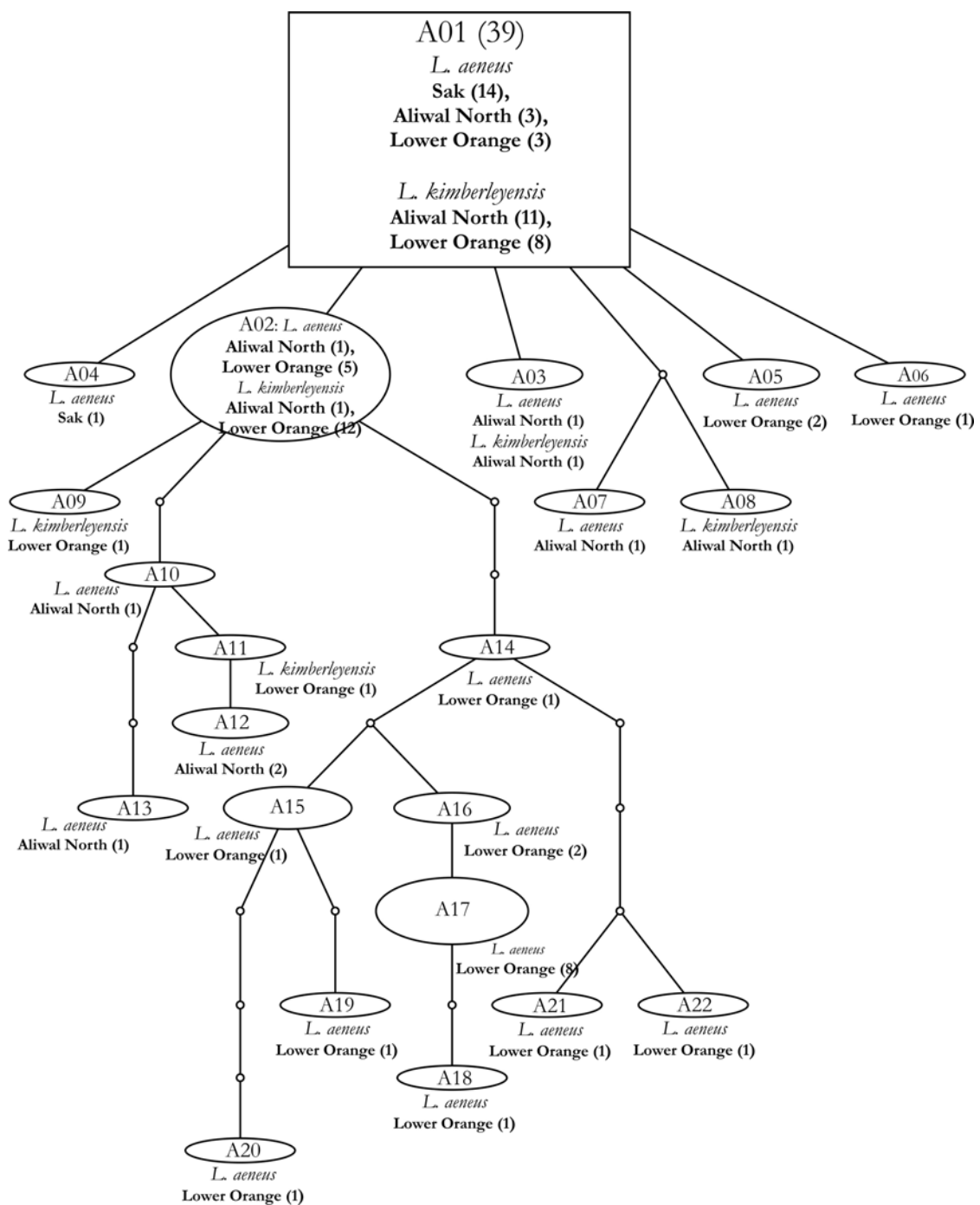
Allele	Unique DNA sequence	N	Field identification of samples and localities
A01	CATCATTCAAATCAAATTATGC	39	<i>L. aeneus</i> Sak (14), Aliwal North (3), Lower Orange (3); <i>L. kimberleyensis</i> Aliwal North (11), Lower Orange (8)
A02	.....A.	19	<i>L. aeneus</i> Aliwal North (1), Lower Orange (5); <i>L. kimberleyensis</i> Aliwal North (1), Lower Orange (12)
A03	.....T.....	2	<i>L. aeneus</i> Aliwal North (1) <i>L. kimberleyensis</i> Aliwal North (1)
A04	.....G.....	1	<i>L. aeneus</i> Sak (1)
A05	....G.....	2	<i>L. aeneus</i> Lower Orange (2)
A06	.....C.....	1	<i>L. aeneus</i> Lower Orange (1)
A07	.....G.....T	1	<i>L. aeneus</i> Aliwal North (1)
A08	.....T.....T	1	<i>L. kimberleyensis</i> Aliwal North (1)
A09	.....C..A.	1	<i>L. kimberleyensis</i> Lower Orange (1)
A10	.....T...T.....A.	1	<i>L. aeneus</i> Aliwal North (1)
A11	.....T...T.G....A.	1	<i>L. kimberleyensis</i> Lower Orange (1)
A12	.....T...T.GG....A.	2	<i>L. aeneus</i> Aliwal North (2)
A13	T.....T..G.TG.....A.	1	<i>L. aeneus</i> Aliwal North (1)
A14	T.....C.....AT	1	<i>L. aeneus</i> Lower Orange (1)
A15	T.....C.....G....CAT	4	<i>L. aeneus</i> Lower Orange (4)
A16	T.....C.....G.....T	2	<i>L. aeneus</i> Lower Orange (2)
A17	T.....C.....GG.....T	8	<i>L. aeneus</i> Lower Orange (8)
A18	T.....C....CT.GG.....T	1	<i>L. aeneus</i> Lower Orange (1)
A19	T.....G....G....CAT	1	<i>L. aeneus</i> Lower Orange (1)
A20	TG....C...G...GG...CA.	1	<i>L. aeneus</i> Lower Orange (1)
A21	T..T.CC.....G..G.AT	1	<i>L. aeneus</i> Lower Orange (1)
A22	T.C..CC.....G..G.AT	1	<i>L. aeneus</i> Lower Orange (1)
		92	

The estimate of Tajima’s D statistic (-1.35) was non-significant indicating that the control region, studied here, is evolving in a neutral fashion (unaffected by selection) and is thus appropriate for studying population/species history. The negative values estimated for two of the neutrality tests may indicate an expansion in population size in the recent past (see later discussion of the mismatch distribution analysis).

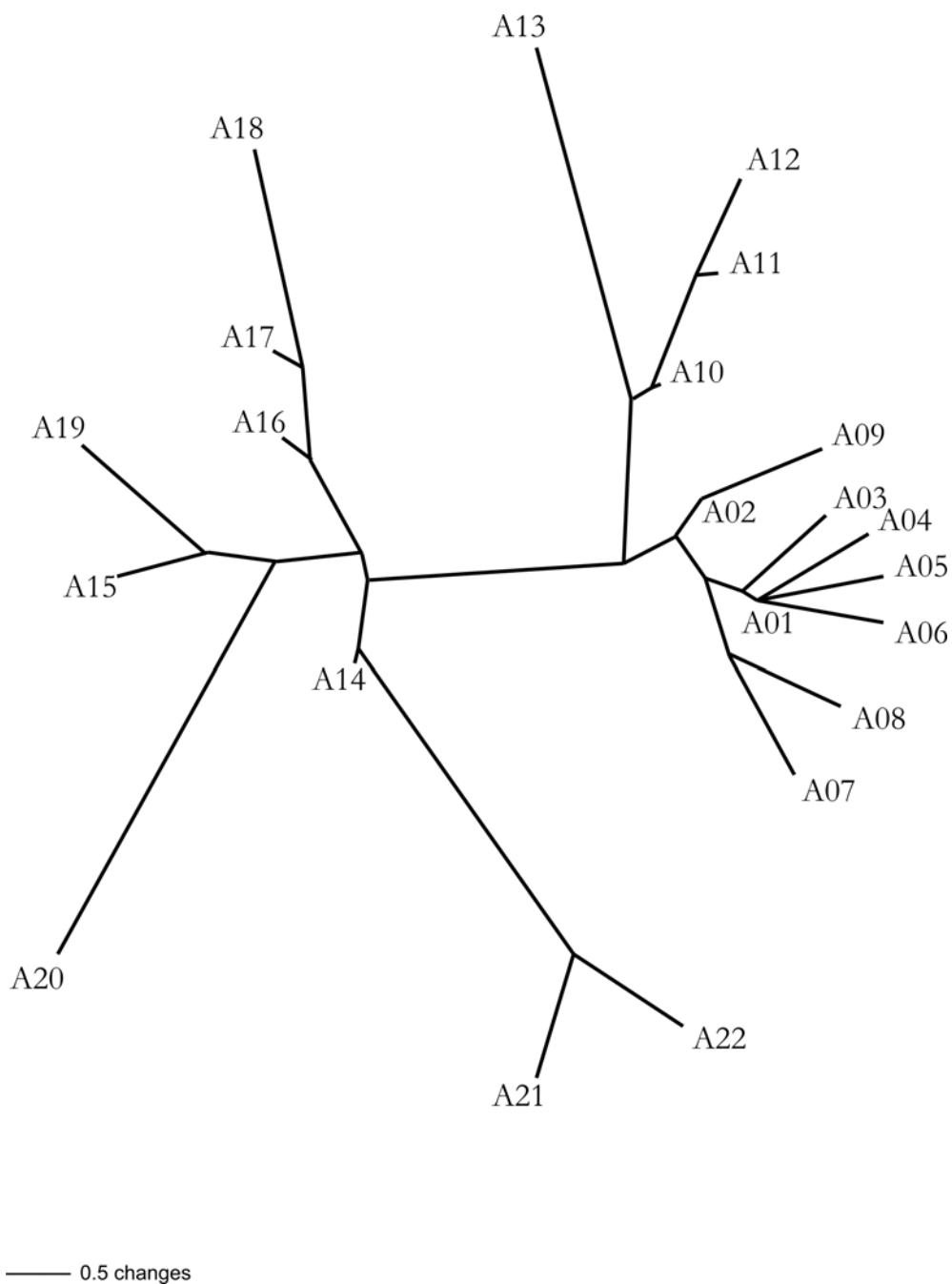
The relationships among the alleles are summarized in the allele network generated using statistical parsimony in TCS (Fig. 1) and in an unrooted distance based phylogenetic analysis (Fig. 2). The TCS analysis proposed allele A01 as the ancestral allele (indicated as a square in the network) due to its high frequency (identified in 39 of 92 individuals), widespread presence (Sak, Aliwal North and Lower Orange) and central position in the network (seven other alleles connect directly to it). Alleles 14-22 from the Lower Orange form a distinctive branch in the network. A few alleles from Aliwal North (A11-A13) are also more distinct than the remainder of the alleles that all connect with allele A01 with few mutational differences between them.

An Analysis of Molecular Variance was used to test several independently defined groupings of the 92 individuals. When considering all individuals as a single Orange-Vaal lineage, most of the variation was recorded between (66%) rather than within the populations (34%), yet the overall population structure ( $F_{ST} = 0.34$ ) was significant. When defining two groups, *L. aeneus* and *L. kimberleyensis*, only 0.4% of the variance could be accounted for by the two groups, ~33% of the variation was found among populations within these two groups and ~66% within populations. When considering the overall distinctiveness of the lower Orange smallmouth yellowfish, it was not surprising that re-defining the groups as lower Orange *L. aeneus* versus the rest, revealed a much higher and significant  $F_{ST}$  value of 0.7. These results indicate that the prior definition of groups are highly influenced by the currently accepted species status of the two forms and the latter should be reconsidered. The results also clearly supports the distinctiveness of some of the lower Orange smallmouth yellowfish.

The mismatch distribution analysis, comparing the trend of observed pairwise sequence differences among the 92 Orange-Vaal yellowfish, showed a significant fit to the trend expected under a population growth model (Fig. 3). Two peaks of pairwise differences are clearly evident, one at 0-1 differences and another at 5-6 differences. The former corresponds to the closely related alleles found (e.g. A01-A10, A11-A13 and A14-A22), whereas the latter reflects the differences between them. The trend suggests a past population expansion which may account for the widespread presence of alleles A01 and A02 throughout the system. This expansion could be natural or may relate to flow changes in the system. An attempt will be made to date the expansion based on current estimates of the rate of mtDNA control region evolution and the generation time observed in yellowfishes. Tentatively using a divergence rate of 3-10% per million years previously suggested for the control region (refs), the peaks at 0-1 and 5-6 differences would reflect diversification occurring within the past 30 000-100 000 and 170 000-560 000 years ago respectively.

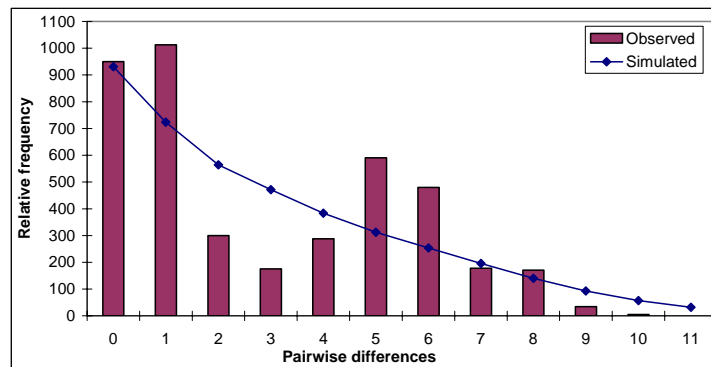


**Figure 1.** Allele network, based on a statistical parsimony analysis conducted in TCS, depicting the relationships between 22 unique maternal alleles identified among 92 Orange-Vaal yellowfish, based on the analysis of 320 base pairs of the 5' variable segment of the mitochondrial DNA control region. Each ellipse/square represents a unique maternal allele defined by a unique set of DNA bases (Table 1). The sizes are drawn relative to the frequency of each of the alleles. Allele 01 was identified as the ancestral allele. The TCS analysis could join alleles with 95% confidence if they were connected with seven or fewer mutational changes. Each line represents a single mutational change and small circles indicate missing alleles (alleles not sampled in the present study or extinct alleles).



**Figure 2.** Unrooted phylogram based on a neighbour-joining analysis of the 22 unique control region alleles identified among 92 Orange-Vaal yellowfish. The branches are drawn relative to the number of mutational changes in the 320 base pair segment of the control region. Notice the longer branches connecting alleles A10-A13 and A14-A22, compared with the close relationship between alleles A01-A09.

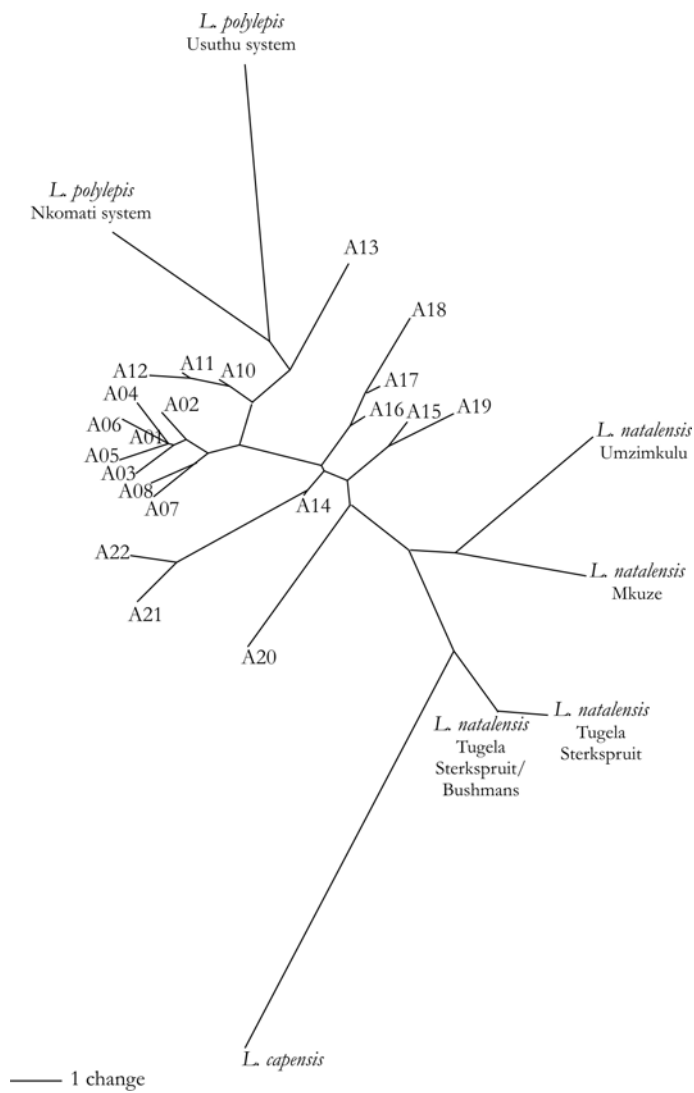
#Diff	Observed	Simulated	Model Freq.
0	950	930.5	928.3
1	1013	723.8	725.8
2	300	564.1	573.9
3	176	471.3	462.7
4	288	383.9	379.9
5	591	312.4	312.6
6	480	253.3	251.4
7	178	195.7	193
8	171	140	139.1
9	34	93.1	93.3
10	5	56.9	58.1
11	0	32	33.5



**Figure 3.** Pairwise comparison of nucleotide differences between 92 Orange-Vaal yellowfish from five sites based on 320 base pairs of the mtDNA control region. The observed data show a significant fit to the trend expected under a population growth/decline model [Sum of Squared deviation: 0.022; P(Sim. Ssd  $\geq$  Obs. Ssd): 0.61; Harpending's Raggedness index: 0.04, P(Sim. Rag.  $\geq$  Obs. Rag.): 0.69].

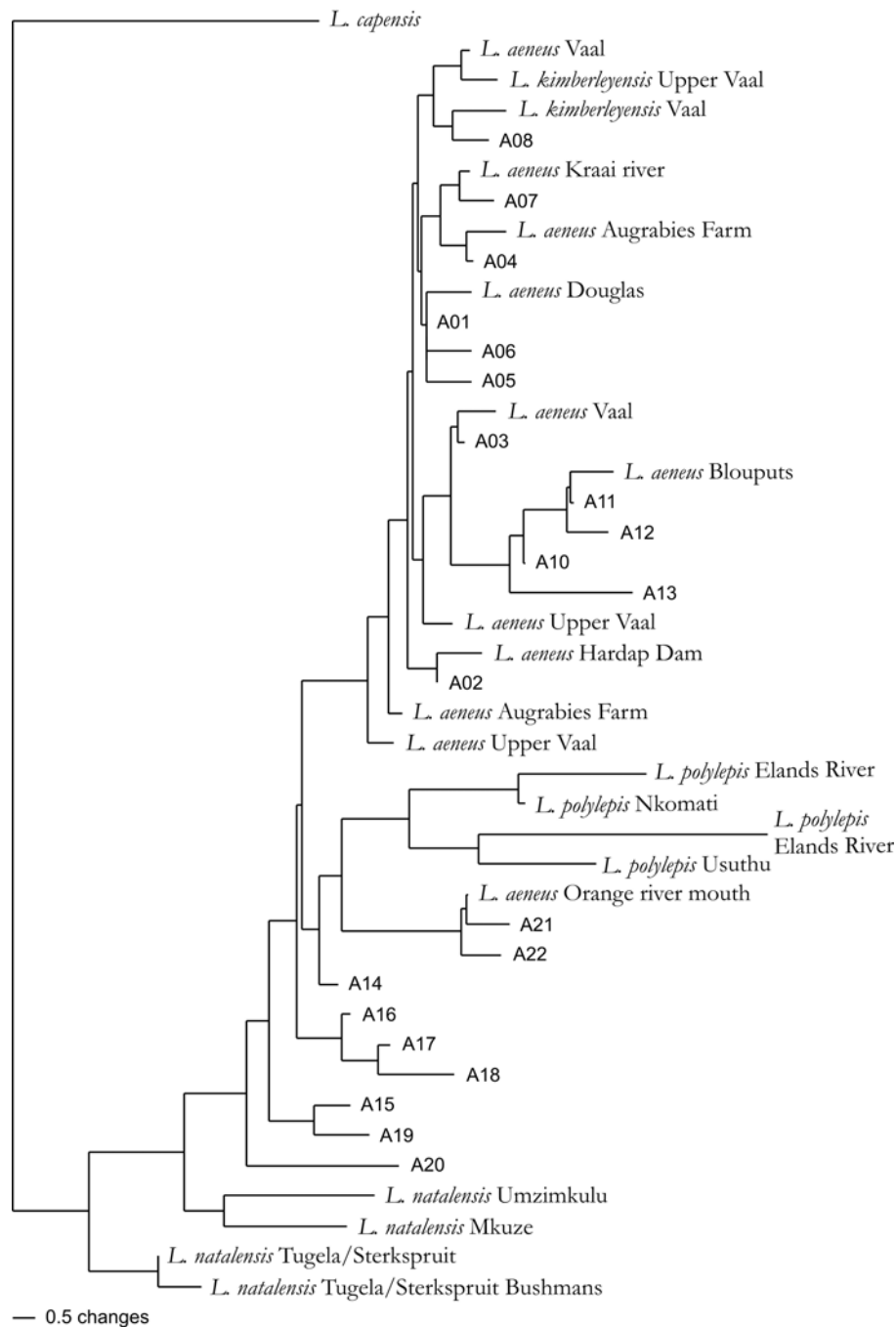
**Variation among 92 Orange-Vaal samples within the context of variability detected in the pilot study and relative to other species within the smallscaled group.**

The unique alleles identified in the present study were analysed with alleles identified as part of the wider sampling done for the pilot study as well as with other members of the smallscaled group (Fig. 4 a and b). Fig. 4 a shows the distinct position of *L. capensis* with *L. natalensis* as its sister group. The unique *L. aeneus* alleles (A14-A22) from the lower Orange clustered separate from the remainder of the *L. aeneus*/*L. kimberleyensis* alleles and of all the 'ingroup' alleles were the closest to *L. natalensis*. With the exception of allele A13, all the other *L. aeneus*/*L. kimberleyensis* alleles clustered together relatively closely. The latter alleles formed the sister group to *L. polylepis* from Swaziland, where two divergent alleles were found. The same pattern is reflected in Fig. 4 (b) were all the alleles from the pilot study were also included. The most distinctive lineages within the 'ingroup' were from the lower Orange and the common allele A01 and its close relatives were found throughout the Orange Vaal system. From the limited analysis of *L. polylepis* and *L. natalensis*, it appears that these two species may harbor diverse lineages and both species should be studied in depth. Analysis 17 *L. natalensis* samples thus far shows clustering of alleles according to river systems represented, with the northern (Mkuze) and southern (Mzimkulu) rivers different from the central Tugela.



(a)





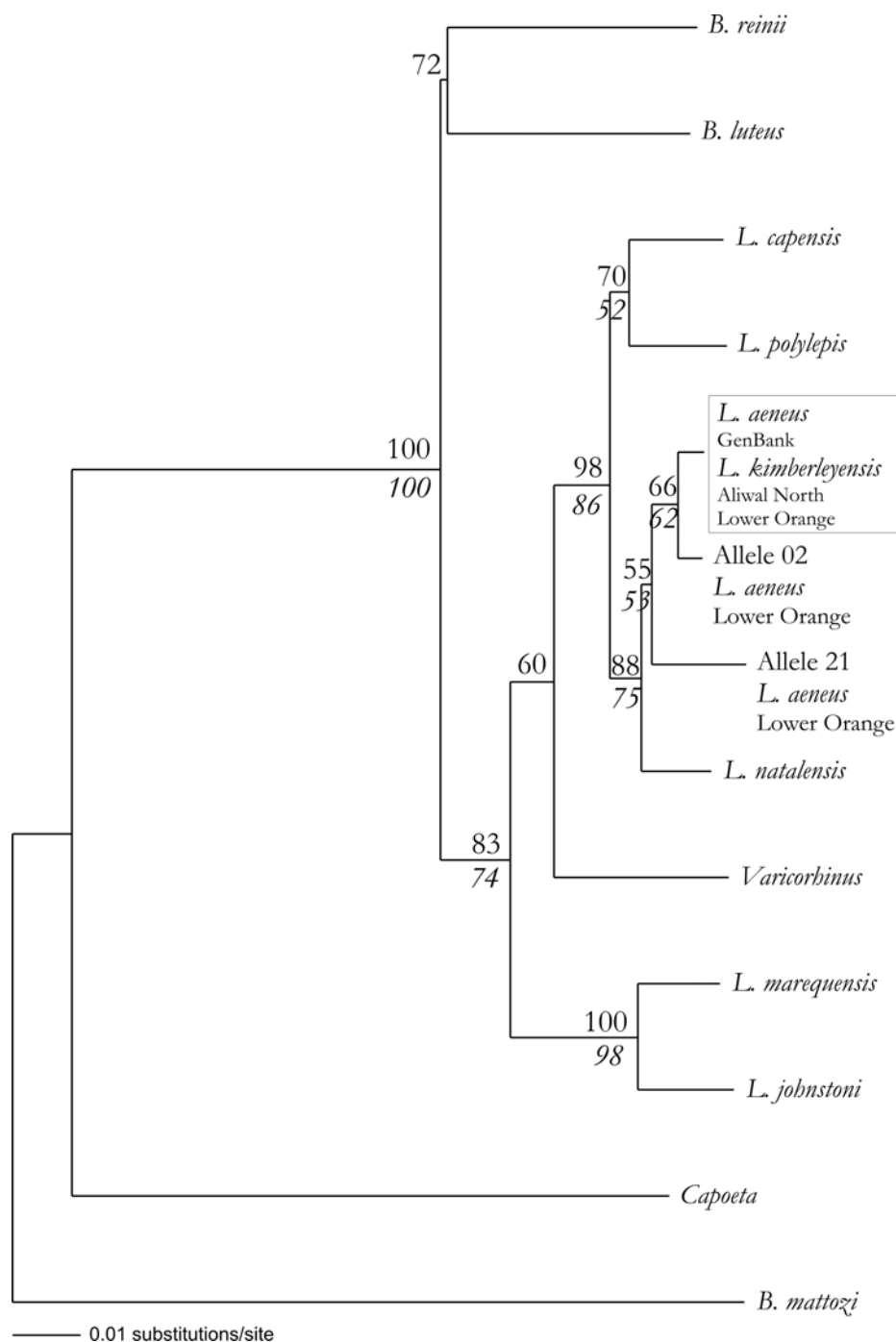
(b)

**Figure 4.** Neighbour-joining analysis of control region sequences among five species of smallscaled yellowfish. *Labeobarbus capensis* was specified as the outgroup based on its position in the preliminary cytochrome *b* phylogeny; (a) shows an unrooted phylogram with only alleles from the present study and the other *Labeobarbus* species compared, while (b) shows a neighbor-joining tree rooted on *L. capensis* and also including alleles from the pilot study.

**Cytochrome *b* phylogeny of the smallscaled group and tentative molecular dating.** The cytochrome *b* gene is a protein coding gene in the mtDNA and has been widely used to study phylogenetic relationships among animal taxa including freshwater fish (see for example Machordom & Doadrio 2001, Tsigenopoulos *et al.* 2002). Additional sequences will be added to the phylogeny but for the purposes of this report the intention was only to compare a few representative alleles from the control region analysis to previously published sequences of related species. The phylogenetic tree (Fig. 5) shows clear support for the shared ancestry and close relationship of the smallscaled group (*L. capensis*, *L. polylepis*, *L. aeneus*/*L. kimberleyensis* and *L. natalensis*). Resolution of the relationships between this group, *L. marequensis*/*L. johnstoni* and *Varicorbinus*, will require additional samples and sequencing of a nuclear gene. Important to note within the context of the present study, is the distinctiveness of allele 21, a *L. aeneus* from the lower Orange and the relatively close relationship between the *L. aeneus*/*L. kimberleyensis* complex and *L. natalensis*.

The use of the sequence divergence (% difference) between species to date the time of divergence between them (i.e. as molecular clocks) has been much debated (see for example Glazko *et al.* 2005). Although varying rates of mutations between different species, the choice of species, the choice of gene and the availability of appropriate fossil calibration rates affect these estimates that are often subject to large standard errors, this method can be used to tentatively date divergence between species. Previous studies implementing molecular dating in cyprinids have generally followed the fossil calibrated rate of ~0.53% divergence per lineage per million years for the cytochrome *b* gene (Dowling *et al.* 2002). Using the approximate pairwise divergence of 1% per million years, the cytochrome *b* divergences in the present study suggest that the smallscaled group radiated from other related species (*Labeobarbus* and *Varicorbinus*) ~ 5-6 million years ago (mya). Most of the differentiation within the smallscaled group date to ~ 2.5-4 mya. Although more cytochrome *b* sequences will be compared within the *L. aeneus*/*L. kimberleyensis* complex, the divergent *L. aeneus* from the lower Orange (represented by allele 21 in the cytochrome *b* pilot study, Fig.5) appear to have split from the remainder of the *L. aeneus* and *L. kimberleyensis* early (1.8-2.3 mya) in the diversification of Orange-Vaal yellowfish lineages from the remainder of the smallscaled group. Differentiation within the rest of the *L. aeneus*/*L. kimberleyensis* complex occurred more recently (within the past 750 000 – 1 million years).

One of the widely accepted geological events that one can use to evaluate these estimates, is the last major break between the Orange and the Olifants systems, dated at around the Oligocene-Miocene boundary (20 million years before present; Dingle & Hendey 1984).



**Figure 5.** Phylogenetic relationships among the smallscaled yellowfish species (*L. aeneus*/*L. kimberleyensis*, *L. natalensis*, *L. polylepis* and *L. capensis*) based on a neighbour-joining and parsimony analysis of 942 base pairs of the mitochondrial DNA cytochrome *b* gene. The values at nodes indicate bootstrap support; above the branches in normal font are the results of the neighbor-joining bootstrap analysis and below the branches in italics the results from the parsimony analysis. Only values above 50% support are indicated and values higher than 70% are generally regarded as good support.

### 3.3.4 Conclusions

- Twenty two unique maternal alleles were identified among 92 Orange-Vaal samples; some alleles are shared between many individuals and were recorded from several sites whereas other alleles occurred at low frequencies.
- In agreement with the pilot study, *L. aeneus* and *L. kimberleyensis* from the Sak River, upper Orange (Aliwal North) and lower Orange (Onseepkans and Pella Drift), shared some maternal alleles. This could be due to the presence of shared ancestral alleles dating to before the split between the two closely related species or could indicate introgressive hybridisation of *L. aeneus* alleles into *L. kimberleyensis*.
- Variation within Orange-Vaal yellowfish is much lower than that observed in *L. natalensis* (the KwaZulu-Natal scaly) based on a small pilot investigation of variation in the latter species. Enough time had elapsed for *L. natalensis* from currently geographically isolated rivers, to develop differences in their mtDNA. With the exception of mtDNA alleles in the lower Orange, the remainder of the lineages within *L. aeneus* and *L. kimberleyensis* indicate a recent rapid spread of a few alleles throughout the system.
- Some of the *L. aeneus* from the lower Orange have more genetically distinct alleles and this area should be investigated in greater depth and treated as a separate conservation unit.

### 3.3.5 References

- Avise, J.C. 2000. *Phylogeography. The history and formation of species*. Harvard University Press, Cambridge MA.
- Bloomer, P. 2006. Identification of conservation units of two yellowfish species *Labeobarbus kimberleyensis* and *L. aeneus*. Orange-Vaal yellowfish genetics pilot study report for the YWG and AngloGoldAshanti Ltd, 27 pp.
- Bloomer, P. & Impson, N.D. 2000. Mitochondrial DNA differentiation in the critically endangered Berg River redbfin *Pseudobarbus burgii*. *Journal of Heredity* 91: 122-127.
- Clement, M., Posada, D. & Crandall, K.A. 2000. TCS: a computer program to estimate gene genealogies. *Molecular Ecology* 9: 1657-1659.
- Dingle, R.V. & Hendey, Q.B. 1984. Mesozoic and tertiary sediment supply to the western Cape basin and palaeodrainage systems of south-western Africa. *Marine Geology* 56: 13-26.
- Dowling, T.E., Tibbets, C.A., Minckley, W.L. & Smith, G.R., 2002. Evolutionary relationships of the plagiopeterns (Teleostei: Cyprinidae) from cytochrome *b* sequences. *Copeia* 3: 655-678.
- Estoup, A., Largiadere, C.R., Perrot, E. & Chourrout, D. 1996. Rapid one-tube DNA extraction for reliable PCR detection of fish polymorphic markers and transgenes. *Molecular Marine Biology and Bioinformatics* 5: 295-298.
- Excoffier, L., Smouse, P.E. & Quattro, J.M. 1992. Analysis of molecular variance inferred from metric distances among DNA haplotypes: application to human mitochondrial DNA restriction data. *Genetics* 131: 479-491.
- Felsenstein, J. 1985. Confidence limits on phylogenies: An approach using the bootstrap. *Evolution* 39: 783-791.

- Glazko, G.V., Koonin, E.V. & Rogozin, I.B. 2005. Molecular dating: ape bones agree with chicken entrails. *Trends in Genetics* 21: 89-92.
- Harpending, H.C. 1994. Signature of ancient population growth in a low-resolution mitochondrial DNA mismatch distribution. *Human Biology* 66: 591-600.
- Hennig, W. 1966. *Phylogenetic Systematics*. University of Illinois Press, Urbana.
- Impson, N.D. & Bloomer, P. 1998/9. Genetic variation between four whitefish *Barbus andrewi* (Pisces: Cyprinidae) populations and some implications for conservation management. *South African Journal of Aquatic Sciences* 24 (1/2): 2-10.
- Jubb, R.A. 1964. Freshwater fishes of southern Africa. 1. The Orange and South Coastal Drainage Basins. *South African Journal of Science* 60: 17-21.
- Knowles, L.L. & Maddison, W.P. 2002. Statistical phylogeography. *Molecular Ecology* 11: 2623-2635.
- Machordom, A. & Doadrio, I. 2001. Evolutionary history and speciation modes in the cyprinid genus *Barbus*. *Proceedings of the Royal Society London B* 268: 1297-1306.
- Nei, M. 1987. *Molecular evolutionary genetics* Columbia University Press, New York, NY, USA.
- Rogers, A.R. 1995. Genetic evidence for a pleistocene population explosion. *Evolution* 49: 608-615.
- Roos, H. 2004. Genetic diversity in the anabantids *Sandelia capensis* and *S. bairdii*: A phylogeographic and phylogenetic investigation. Unpublished MSc dissertation, University of Pretoria.
- Rozas, J. Sanchez-DelBarrio, J.C., Messeguer, X. & Rozas, R. 2003. DnaSP, DNA polymorphism analyses by the coalescent and other methods. *Bioinformatics* 19: 2496-2497.
- Saitou, N. & Nei, M. 1987. A neighbor-joining method: a new method for reconstructing phylogenetic trees. *Molecular Biology and Evolution* 4: 406-425.
- Sambrook, J., Fritsch, E.F. & Maniatis, T. 1989. *Molecular cloning: a laboratory manual*. Cold Spring Harbor Laboratory Press, New York.
- Schneider, S., Roessli, D. & Excoffier, L. 2000. ARLEQUIN ver 2.000: a software for population genetics data analysis. Genetics and Biometry Laboratory, University of Geneva, Switzerland.
- Swartz, E.R. 2005. Phylogeny, phylogeography and conservation of the Redfins (*Pseudobarbus*). Unpublished PhD thesis, University of Pretoria.
- Swofford, D. L. 2003. *PAUP\* Phylogenetic analysis using parsimony (\*and other methods), version 4*. Sinauer Associates, Sunderland, Massachusetts.
- Tajima, F. 1983. Evolutionary relationship of DNA sequences in finite populations. *Genetics* 105: 437-460.
- Tajima, F. 1989. Statistical method for testing the neutral mutation hypothesis by DNA polymorphism. *Genetics* 123: 585-595.
- Thompson, J.D., Gibson, T.J., Plewniak, T.F., Jeanmougin, F. & Higgins, D.G. 1997. The Clustal X windows interface: Flexible strategies for multiple sequence alignment aided by quality analysis tools. *Nucleic Acids Research* 24: 4876-4882.
- Tsigenopoulos, C.S., Rab, P., Naran, D. & Berrebi, P. 2002. Multiple origins of polyploidy in the phylogeny of southern African barbs (Cyprinidae) as inferred from mtDNA markers. *Heredity* 88: 466-473.
- Van Niekerk, R. 2004. Phylogeography of the Cape galaxias *Galaxias zebratus*. Unpublished MSc dissertation, University of Pretoria.
- Waters, J.M. & Cambray, J.A. 1997. Intraspecific phylogeography of the Cape galaxias from South Africa: Evidence from mitochondrial DNA sequences. *Journal of Fish Biology* 50: 1329-1338.

Wright, S. 1951. The genetical structure of populations. *Annals of Eugenics* 15: 323-354.

## 3.3.6 Appendix

**Table 1.** Material from the pilot study (total sample size 264: 84 *L. kimberleyensis* and 180 *L. aeneus*) of which some alleles were used for analysis in the present study.

Species	Locality	Number of specimens	Code for locality in genetic analysis
<i>L. kimberleyensis</i>	Bothaville	2	LMVr
<i>L. aeneus</i>	Bothaville	3	SMVr
<i>L. aeneus</i>	Upper Vaal	6	BaUV
<i>L. kimberleyensis</i>	Upper Vaal	2	BkUV
<i>L. aeneus</i>	Yellow Fish Paradise	10	SMVr
<i>L. aeneus</i>	Skanskoppie	9	BaSVR
<i>L. aeneus</i>	Douglas	1	BaDVR
<i>L. aeneus</i>	Blouputs	10	BaBOR
<i>L. aeneus</i>	Augrabies Farm	10	BaAOR
<i>L. kimberleyensis</i>	Keimoes Bridge	1	BkKBOR
<i>L. aeneus</i>	Sak River poort	20*	BaSRB
<i>L. aeneus</i>	Kraai river	20*	BaKRB
<i>L. aeneus</i>	Hardap Dam	20*	BaAHD
<i>L. aeneus</i>	Gariep Dam	20*	BSA/BaDN
<i>L. kimberleyensis</i>	Gariep dam	20*	BSA
<i>L. aeneus</i>	Gariep Dam	9	BaRH
<i>L. kimberleyensis</i>	Gariep Dam	3	BkRH
<i>L. kimberleyensis</i>	Orange River Mouth	2	BkO
<i>L. aeneus</i>	Orange River Mouth	1	BaO
<i>L. kimberleyensis</i>	Vaal/Harts confluence	6	VO
<i>L. aeneus</i>	Orange River	22	LaOR
<i>L. aeneus</i>	Douglas (Vaal)	19	vdL
<i>L. kimberleyensis</i>	Gariep dam	22	GdLa
<i>L. kimberleyensis</i>	Douglas (Vaal)	22	VDLk
<i>L. kimberleyensis</i>	Alleanskraal Dam (Vaal)	4	ADLk